



2019

AGENTE DI ZONA

CAMPING - CARAVAN - CAMPER

Catalogo - Catalogue

N. 37 | 2019



Membri dell'associazione
internazionale operatori
settore campeggio
e turismo all'aria aperta

LA TR.EM. PRODUCE
SOLO QUALITÀ





*Una vita di lavoro e successi
navigando verso i 50 anni ...*

Proprio cinquant'anni fa, Franco Marzaduri decise di fondare Trecciatura Emiliana srl (T.R.EM. srl), dedicandosi alla produzione di corda elastica, inizialmente per coprire le ruote posteriori delle biciclette da donna, un articolo tanto inusuale quanto storico, successivamente per fermare i bagagli sul tetto delle auto.

Tuttavia, tutti sappiamo che le mode cambiano e la tecnologia si deve adeguare ai nuovi tempi, così T.R.EM. iniziò a produrre corda per vela, traino sci e articoli per la sicurezza in mare, espandendo successivamente la produzione allo stampaggio plastica (doccette, sportelli, luci di navigazione, ecc...), lavorazione legno (scalette e passerelle), lavorazione alluminio e acciaio (mezzi marinai, pagaie, porta zattera, supporti motore, ecc...).

Grazie a questo spirito imprenditoriale, la storica Azienda di Osteria Grande è riuscita ad esportare i propri prodotti in tutto il mondo; non sarà difficile trovarsi a bordo di un traghetto nella baia di Sydney, piuttosto che su di un catamarano ai Caraibi, con un mezzo marinaio T.R.EM. in mano!

T.R.EM. è la mia vita. La mia famiglia. La mia storia. Una storia fatta di sogni, di duro lavoro, una storia di sacrifici e di sfide, una storia di gioie e di orgoglio. Con la certezza di passare almeno altri 50 anni in mare con voi, desidero ringraziare calorosamente tutti i nostri clienti, vecchi e nuovi, per la fiducia dimostrata in tutti questi anni.

*Franco Marzaduri
President*

A life of work and success

50 years ago I decided to found Trecciatura Emiliana srl (T.R.EM. Srl) focusing on the production of shock cords used to cover the rear wheels of women's bicycles. That article was very unusual but now it belongs to the history of our Company. Later shock cords have been used to lock luggage on car roofs.

However everybody knows that habits change and that technology needs to be adapted to the new times, so T.R.EM. started to produce sailing rope, ski rope and safety items for boating, expanding the production range with the plastic molding (showers, hatches, navigation lights), woodworking (ladders and gangways), aluminium and stainless steel working (boat hooks, oars, liferaft frames, motor brackets).

Thanks to this entrepreneurial spirit, in these 50 years our Company has managed to export its products all over the world; I think it will not be difficult to find a boat hook made by T.R.EM. when sailing on a ferry through Sydney Bay or on board a Caribbean catamaran!

T.R.EM. is my life. My family. My story. A story of dreams, of hard work, a story of sacrifice and challenges, a story of happiness and pride. So I would also like to thank our employees as well as our customers for the trust shown over the years and I look forward to spending another 50 years at sea with you all.





ANNI DI STORIA YEARS OF HISTORY

1968



2018



*Franco Marzaduri
con i figli Davide e Massimiliano
e la moglie Lorena*

*Franco Marzaduri
with his sons Davide & Massimiliano
and his wife Lorena*



ORDINI

Si invita la Gentile Clientela (per evitare malintesi) a conferire ordini scritti specificando: Codice Cliente — Codice Articolo — Descrizione Articolo.

L'importo minimo per ordine è di € 150,00 netti. Ordini di importo inferiore non vengono evasi.

PAGAMENTI

La prima fornitura: anticipato o contrassegno con addebito. Forniture successive verranno evase alle condizioni concordate (purché vengano forniti elementi di informazione atti a garantire la solvibilità). Le eventuali R.B. respinte annulleranno eventuali ordini in corso. Trascorso il termine stabilito per il pagamento, decorreranno gli interessi commerciali.

PREZZI

I prezzi indicati sono consigliati al pubblico **IVA ESCLUSA**.

I prezzi indicati sono da ritenersi puramente indicativi e non contrattuali e possono differire da quelli applicati dai nostri rivenditori per molteplici ragioni.

I prezzi non sono impegnativi e possono subire variazioni fino al momento della spedizione.

DISPONIBILITÀ

Alcuni prodotti e/o servizi presentati nel catalogo potrebbero non essere disponibili.

FOTOGRAFIE E COLORI

Le fotografie e le informazioni indicate nel presente catalogo non fanno parte dell'ambito contrattuale e non potranno in nessun caso essere considerate per eventuali reclami.

I colori riprodotti nelle fotografie sono da ritenersi puramente indicativi.

La pubblicazione e l'utilizzo del materiale fotografico di proprietà TR.EM. deve essere autorizzato dal nostro responsabile commerciale a mezzo lettera sottoscritta dallo stesso.

SALDI ORDINI

Le quantità di ordini a saldo verranno spedite SALVO ORDINE CONTRARIO, appena possibile, od unitamente ad un nuovo ordine ai prezzi di listino in vigore per importi non inferiori a € 150,00.

IMBALLO E ASSICURAZIONE

Addebito del 1% del fatturato per imballo e assicurazione a valore totale della merce trasportata.

SPEDIZIONI

Le merci sono vendute franco nostro magazzino di Osteria Grande (Bologna). Tutte le spedizioni sono comunque assicurate da noi contro i rischi di furto o smarrimento anche parziale. Per rendere operante tale assicurazione, la ricezione dal vettore di spedizioni con colli mancanti, o danneggiati, o aperti, deve essere fatta «con riserva». Il mezzo di trasporto può essere quello indicato dal Cliente. In mancanza di precise istruzioni in merito effettueremo la spedizione con il mezzo più conveniente. Eventuali ritardi nelle consegne non potranno giustificare richieste di rimborso di pagamenti di danni. Le spedizioni verranno inoltre effettuate nei quantitativi minimi di confezione.

CAMPIONI

Saranno sempre addebitati al prezzo del listino in vigore.

ATTENZIONE:

Le caratteristiche tecniche ed estetiche degli articoli sono indicative e possono essere variate in qualsiasi momento e non possono essere considerate per eventuali reclami.



PRICES

Those are per our latest Price List operative on the moment of the ordering. Our prices are, however, subject to alteration without notice.

Minimum order: EURO 1000.

PACKAGING

Packaging is free of charge only if ordered goods do match with the packaging units shown in our catalogue. Any ordered quantity different from the minimum packaging planned for in the catalogue will cause an increase of 2% of the goods price, due to additional internal charges for handling it.

DELIVERY

Prices quoted are valid for goods sold Ex Works. Our customers must indicate the name and address of the forwarding agent they choose. If not, shipment will be made through the usual TR.EM. forwarder. However, on demand, we can supply free your town, debiting a competitive rate on your invoice.

INSURANCE

Goods will be insured by the seller warehouse, debiting the rate to the buyer. To enforce this insurance, when receiving goods through a forwarding agent where some packages are missing, damaged or open, please accept them "under reserve" only.

PAYMENT

By opening of irrevocable Letter of Credit on our Bank of Bologna.

SAMPLES

You will be charged for.

DESPATCH

The term of delivery and the quantities of the articles written on our Confirmation are not binding. In any case we will not be forced to pay a penalty in case of delayed or partial delivery. All differences will be settled by Bologna Courts.

PROPERTY RESERVE

Goods remains our property up to the complete payment of their price.

RESPONSIBILITY

TR.EM. srl will replace defective items only after they have been given back to be analysed, and only when the defect has been acknowledged as such.

The purchaser or the user is obliged to see whether each item is or is not suited to its relevant use. In no case shall the responsibility of TR.EM.srl exceed the cost of replacing the product.

INTERNATIONAL SALES TEAM

 **Export Manager**
Mr. Matteo Belletti

 +39 348 0014743

 **Orders & Shipment Management**
Mrs. Cristina Mandrioli  +39 051 6950541

 **Orders & Payments Management**
Mrs. Sonia Scheda  +39 051 6950507

 **Sales Assistant**
Mrs. Simona Pirazzini  +39 051 6950554

info: export@trem.net | web: www.trem.net
fax : +39 051 945618

SIAMO PRESENTI IN OLTRE 60 PAESI

ITALIA

Direttore commerciale e Ricerca prodotto

Davide Bertuzzi - Marzaduri

commerciale@trem.net

+39 051 6950542

Resp. amministrativo

Luisa Ferrante

amministrazione@trem.net

+39 051 6950549

Ricevimento ordini e spedizioni

Francesca Bombardini

commerciale@trem.net

+39 051 6950513

Erika Biancoli

commerciale@trem.net

+39 051 6950508

Ricevimento ordini

Simona Bianconi

commerciale@trem.net

+39 051 6950510

 **WhatsApp: 340 2747740**

web: www.trem.net | fax: **800 239848**

▶ Lombardia - Piemonte - Valle d'Aosta

Lodi Giovanni

cell. 335 5248795
tel. 02 365 85 002
fax 02 365 85 003

lodirappresentanze@gmail.com

▶ Emilia Romagna - Marche

Sergio Simoni

cell. 329 9458184
tel. e fax 051 479981
simonisergio54@libero.it

▶ Liguria

Roberto Guaragno

cell. 335 1039709
tel. 010 6456134
roberto.guaragno@gmail.com

▶ Trentino Alto Adige - Veneto Friuli Venezia Giulia

Dario Bracco

cell. 335 - 6026711

email: nautica@dariobracco.it

▶ Abruzzo

Giuseppe Ballarini

cell. 335 284009

gb.ballarinigiuseppe@gmail.com

▶ Lazio

Andrea Guadagnini

cell. 337 755872
fax 06 91014444
guada.rap@alice.it

▶ Puglia - Basilicata

Francesco Caforio

cell. 338 8624715
tel. 0832 733384
fcaforio@gmail.com

▶ Campania

Dario Alfano

cell. 345 3077944

darioalfano@alice.it

▶ Sardegna

Ennio Fozzi

cell. 333 1891710
fax 178 6011352
ennio-fozzi@tiscali.it

▶ Sicilia - Calabria

Giuseppe Caccamo

cell. 348 - 6036031
tel. 095 - 4032150
fax 095 - 495869
email: info@giuseppecaccamo.com



CONDIZIONI EVENTUALE RESO - RETURN FORM



TREM s.r.l. Via Friuli, 5 - 40060 Osteria Grande - Bologna - Italy
Tel. 39-051 69 50 511 Fax: 39-051 94 56 18
e-mail: info@trem.net internet: www.trem.net

AUTORIZZAZIONE AL RESO MERCI N° XX/2018

AUTORIZZATO DA:

CLIENTE:

COD. CLIENTE:

ARTICOLO	Q.Tà	MOTIVO DEL RESO

DDT/FATTURA N° DEL

CON LA PRESENTE SI AUTORIZZA IL RESO DELLA SUDETTA MERCE; **È INDISPENSABILE ALLEGARE COPIA DI TALE AUTORIZZAZIONE ALLA DDT**, AL FINE DELL'ACCETTAZIONE AL NS. MAGAZZINO.

SENZA LA PRESENTE AUTORIZZAZIONE IL RESO NON SARÀ ACCETTATO!

La merce dovrà ritornare completa della relativa documentazione, di tutti gli accessori e nel proprio imballaggio originale o comunque in un imballaggio di qualità equivalente.

TRASPORTO: il materiale sarà trasportato alle seguenti condizioni

VS CURA (Porto Franco) NS CURA (Porto Assegnato con nostro corriere convenzionato) ALTRO (SPECIFICARE)

NOTE: _____

ATTENZIONE:

- Nel caso di reso non dovuto a ns. errore spedizione verrà addebitato un importo pari al 15% del valore della merce, più Euro 10 per spese contabili (come da condizioni indicate su catalogo n. 34 del 2008)
- La validità della presente è di 10 giorni a far data dalla presente. Decorso questo termine non sarà più accettato dal nostro magazzino (salvo diversi accordi presi).

Osteria Grande, li:

TREM srl



TREM srl works under the ISO 9001:2015 European Standard Quality

POLITICA AZIENDALE PER LA QUALITÀ

La TR.EM. srl ritiene che la qualità debba diventare uno strumento di gestione dell'azienda e attraverso il quale organizzare, gestire e tenere sotto controllo l'andamento aziendale, non solo dal punto di vista della qualità del prodotto e della soddisfazione del Cliente, ma anche della razionalità dell'organizzazione e dell'efficienza.

Questo nella certezza che ciò comporti crescita delle quote di mercato, aumento di fedeltà da parte della clientela e incremento di competitività. La politica per la qualità della TR.EM. è sintetizzabile con la seguente affermazione:

fornire al mercato prodotti e servizi con un elevato e costante standard di qualità nel massimo rispetto dei termini contrattuali.

In particolare gli obiettivi per la qualità si rivolgono:

- AL RAPPORTO CON IL CLIENTE
- AL PRODOTTO
- AL RAPPORTO CON I FORNITORI
- ALL'ORGANIZZAZIONE AZIENDALE

Allo scopo quindi di fornire al Cliente un prodotto che soddisfi le esigenze di qualità, sicurezza, funzionalità e affidabilità, la TR.EM. ha posto in essere delle procedure atte a garantire che i materiali di acquisto esterni siano conformi a quanto ordinato, e che il processo produttivo avvenga in conformità a tutte le caratteristiche previste.

Queste procedure si suddividono in attività di prove e controllo in fase di accettazione merce, di controllo durante il processo produttivo, di prove, controllo e collaudo del prodotto finito.

La TR.EM. garantisce inoltre la rintracciabilità di un prodotto finito per un tempo di 3 anni a partire dalla data di confezionamento e limitatamente ai prodotti in cui la sicurezza costituisce un requisito essenziale, richiesto da normative, il cui rispetto costituisce garanzia sia all'utilizzatore che al produttore; allo scopo di poter ricostruire la storia di un prodotto ricollegandolo alla documentazione relativa, raccolta durante il processo produttivo.



COMPANY QUALITY POLICY

TR.EM. SRL aim is to become a company organising, managing and controlling its own trends, not only concerning the products' quality and customers' satisfaction, but also concerning the very rational organisation and efficiency. This, because we are sure in an increase of our market shares, customers' loyalty and competitiveness.

TR.EM.'s quality policy states to provide the market with products and services having a high and continuous quality standard, in the highest compliance with the contract terms.

Particularly, the quality aims refer to:

- RELATIONS WITH THE CUSTOMER
- PRODUCT
- RELATIONS WITH SUPPLIERS
- COMPANY'S ORGANISATION

Therefore, in order to supply the customer with the product accomplishing the quality, safety, functionality and reliability needs, TR.EM. set procedures to assure that the purchased materials comply the orders and the production procedure is in conformity with all expected features. These procedures are shared in testing and checking upon the goods receiving and in checking during the production process, checking and running tests on the finished product.

Moreover, TR.EM. assures the tracking of finished products, for three years from the packaging's date, for products only, with safety as basic requirement and as per the current rules. Rules to be respected, to assure both the final user and the supplier, in order to make possible the reconstruction of the product's process with the related file, issued during the production process.



Il complesso aziendale visto da nord - TR.EM. company plant view (from north)

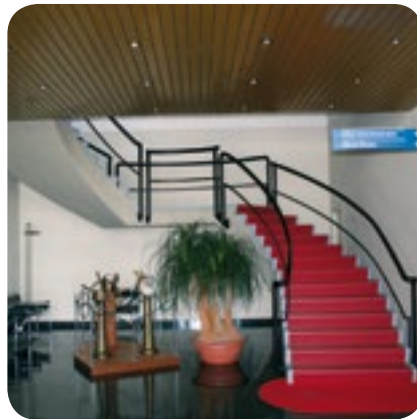

Gli uffici - Offices

1

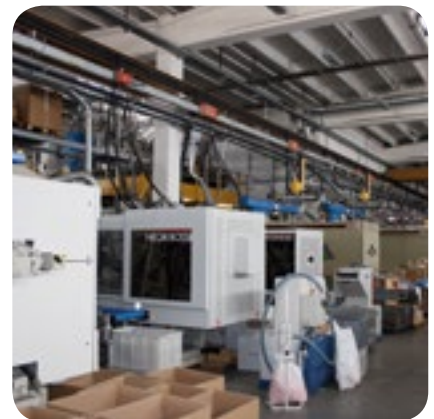

Reparto stampaggio plastica - Plastic injection workshop

2



Magazzino componenti - Components warehouse

3



Nuovi reparti (lato sud) - New plant (from south)

4



A



B



C



D

Corderia (A) - Officina (B) - Magazzino prodotti finiti (C) - Falegnameria (D)
Rope production plant (A) - Workshop (B) - Warehouse (C) - Carpentry (D)

5

CAMPING - CARAVAN - CAMPER

01

pag.
12-14



Scale cuccetta

Bunk ladders

Scale in legno
Profilo tondo Ø 25
Profilo ovale 35 x 20
Profilo ovale 50 x 25

Wooden ladders
Round profile Ø 25
Profile 35 x 20
Oval profile 50 x 25

02

pag.
15-20

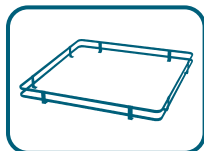

**Portapacchi
scale esterne**

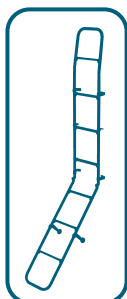

**Roof racks
external ladders**

Profilo tondo Ø 25
Profilo ovale 35 x 20
Ducato
Profilo ovale 50 x 25

Round profile Ø 25
Profile 35 x 20
Ducato
Oval profile 50 x 25

03

pag.
21-29

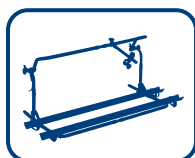

**Portabici
e garage**

**Cycle-holders
and garage**

Portabici camper
Portabici caravan
Portabici 4 x 4
Portasci 4 x 4
Accessori garage

Cycle-holder for camper
Cycle-holder for caravan
Cycle-holder 4 x 4
Ski-holder 4 x 4
Accessories for garage

04

pag.
30-46



**Accessori da
esterno**

**Outdoor
accessories**

Cerniere inox Aisi 316
Oscuranti esterni
Oscuranti interni
Lastre per finestre
Ruotini di appoggio
Martinetti di stazionamento
Cunei livellatori
Serrature
Aeratori
Gradini
Cartelli carico sporgente
Gas

Hinges Aisi 316
Outer curtains
Inner curtains
Window plates
Wheels
Standing holders
Balancing wedges
Locks
Ventilators
Steps
Exceeding load panels
Gas

05

pag.
47-56



**Accessori da
interno**

**Indoor
accessories**

Molle a gas
Maniglie
Tendine oscuranti
Retine portaoggetti
Salva-caduta cuccetta
Gambe per tavolo
Fermapiatti

Gas springs
Hand rails
Sunset curtains
Nets as object-holder
Protection nets for beds
Table pedestals
Multipurpose holder

CAMPING - CARAVAN - CAMPER



06

Taps/Mixers	Rubinetti/Mixer
Showers	Docce
Valves	Valvole
Outlets and caps	Bocchettoni e tappi
Tanks	Serbatoi
Connections and pipes	Raccordi e tubi
Pumps	Pompe

pag.
57-72

Water

Acqua



07

Lightning	Illuminazione
Plugs and connectors	Spine e connettori
Batteries	Batterie
Battery switches	Staccabatteria
Battery boxes	Cassette batteria
Gas detectors	Rilevatori gas
Inverters	Inverter
Wall supports for TV	Porta TV
Flashlights	Torce
Accessories 12V.	Accessori 12V.
Interruttori	Switches
Fans & refrigerator switches	Ventole e interruttori frigo

pag.
73-96

Energy

Energia

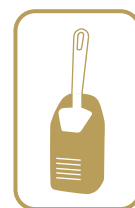

08

Chemicals for WC	Prodotti chimici per toilette
Toilettes	Toilettes
Pipes and cleaning sets	Tubi e kit pulizia
Washers	Lavatrici
Adhesives	Collanti
Sealing devices	Sigillanti
Buckets	Secchi

pag.
97-105

Cleaning and maintenance

Pulizia e manutenzione



09

Water bags & sunshowers	Ghirbe e docce
Binoculars	Binocoli
Compasses	Bussole
Dinner set	Posate
Inflators	Gonfiatori
Ropes and hooks	Cordame e ganci
Tent poles	Paleria
Tent pegs	Picchetti
Rubber stretchers	Elastici
Studs and butts	Borchie e bottoni

pag.
106-118

Camping

Camping

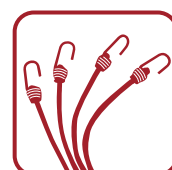

10

Can holders	Portabicchieri
Camp stoves	Fornelli camping
Fuel tanks	Canestri carburante
Shock cords	Corde elastiche
Tow ropes	Corde traino
Multipurpose ropes	Corde usi vari
Winches	Argani

pag.
119-141

Different accessories

Accessori vari



Scale cuccetta Bunk ladders

Scale Cuccetta-Bunk Ladders

4 Gradini Alu - 4 Alu steps 35 x 20

made by

ADRIA



Scala cuccetta in alluminio anodizzato

Completa di attacchi a parete.
Confezione in sacchetto singolo.

Bunk bed ladder made of anodised aluminium

Supplied with wall supports.
Single packing in polybag.

Articolo - Item	Modello Model	Gradino Step	Larghezza Width cm.	Lunghezza Length cm.	€/pc.
S 46 04 108	A	Alu	30	110	

5 Gradini - 5 steps 35 x 20 gradini inclinati e piede snodato

made by

- Gradino inclinato di 15°
- Sloping step of 15°



- Con piede snodato
- With articulated foot

Scala cuccetta in alluminio anodizzato

Completa di attacchi a parete.
Confezione in sacchetto singolo.

Bunk bed ladder made of anodised aluminium

Supplied with wall supports.
Single packing in polybag.

Articolo - Item	Mod.	Attacco - Support	↑ cm.	€/pc.
S 46 05 164	A	Lungo-Long	164x30	
S 46 05 165	B	Parete-Wall	164x30	

4 Gradini Alu - 4 Alu steps 35 x 20 piede snodato e gradini inclinati

- Con piede snodato e gradino inclinato
- With articulated foot and sloping step

made by

ADRIA



Scala cuccetta in alluminio anodizzato

Completa di attacchi a parete.
Confezione in sacchetto singolo.

Bunk bed ladder made of anodised aluminium

Supplied with wall supports.
Single packing in polybag.

Articolo - Item	Mod.	Attacco Support	Gradini Steps	↑ cm.	Profilo Profile	€/pc.
S 46 04 148	A	Lungo-Long	4	148 x 30	35 x 20	
S 46 04 149	B	Parete-Wall	4	148 x 30	35 x 20	

5 Gradini Alu - 5 Alu steps 35 x 20 piede snodato

made by

ADRIA

- Con piede snodato antiscivolo
- With antisliding articulated foot

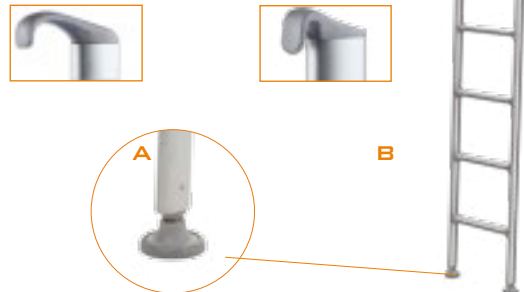

Scala cuccetta in alluminio anodizzato

Completa di attacchi a parete.
Confezione in sacchetto singolo.

Bunk bed ladder made of anodised aluminium

Supplied with wall supports.
Single packing in polybag.

Articolo - Article	Mod.	Attacco Support	Gradini Steps	Profilo Profile	↑ cm.	€/pc.
S 30 35 145 S	B	Parete-Wall	5	35 x 20	155 x 30	
S 30 35 142	A	Lungo-Long	5	35 x 20	144 x 30	
S 30 35 155	A	Lungo-Long	5	35 x 20	155 x 30	
S 30 35 120	A	Lungo-Long	5	35 x 20	120 x 30	

5 Gradini Alu - 5 Alu steps

made by  **ADRIA**

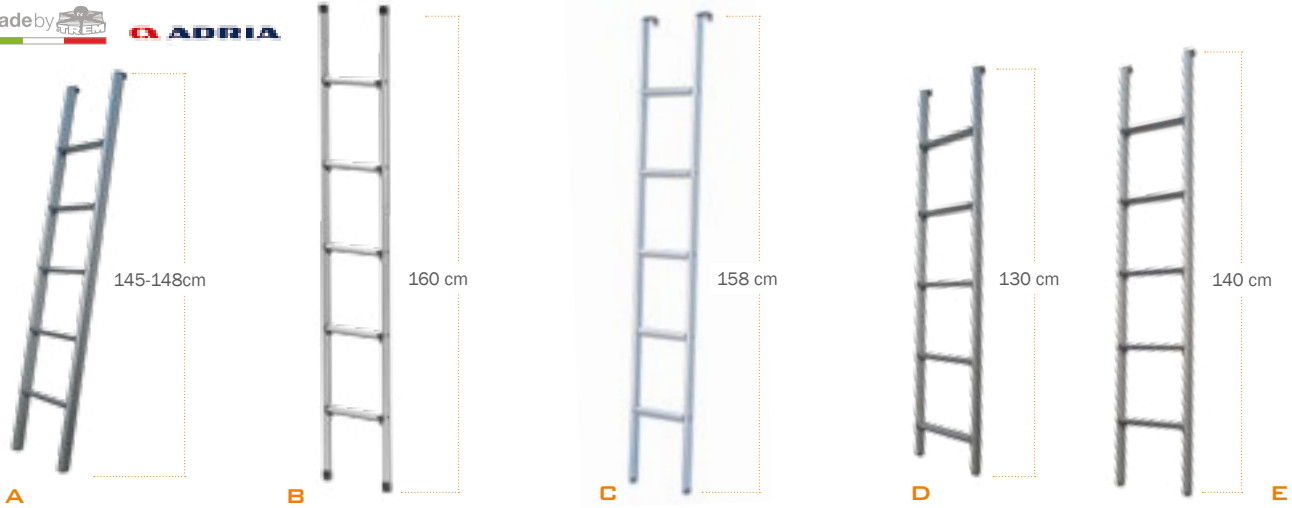

Scala cuccetta in alluminio anodizzato

Completa di attacchi a parete.
Confezione in sacchetto singolo.

Bunk bed ladder made of anodised aluminium

Supplied with wall supports.
Single packing in polybag.

Articolo - Item	Modello - Model	Gradino - Step	Profilo - Profile	Larghezza - Width cm.	Lunghezza - Length cm.	€/pc.
S 30 26 145	A	Alu	50 x 25	30	145	
S 43 05 160	B	Alu	Ø 25	21	160	
S 45 05 128	C	Alu	35 x 20	28	158	
S 46 05 126	D	Alu	35 x 20	28	130	
S 46 05 138	E	Alu	35 x 20	28	140	

6 Gradini Alu - 6 Alu steps 50 x 25

made by  **ADRIA**

Scala con attacco a cuccetta

In tubo di alluminio.
Modello a 6 gradini.
Confezione singola.

Ladder for bunk beds

Made of aluminium
Provided with 6 steps.
Single packing.

Articolo Article	Larghezza Width cm.	Lunghezza Length cm.	€/pc.
S 30 26 148	30	168	



5 Gradini Legno - 5 Wooden steps

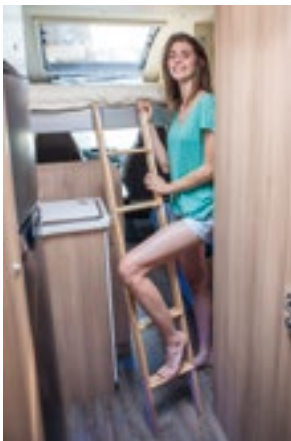

made by 



Protezioni salvacaduta Protection against falls

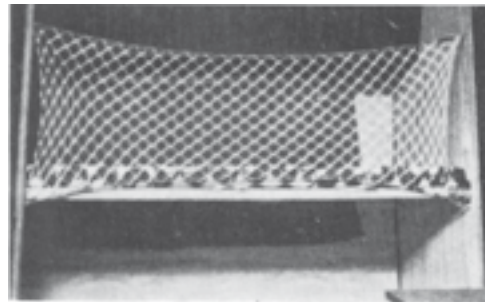

made by 

Scala in legno 5 gradini con gradino pedata 100 mm. completa di attacchi

Confezione singola.

Wooden ladder 5 steps with supports

Single packing.

Articolo - Article	Larghezza - Width cm.	Lunghezza - Length cm.	€/pc.
S 14 15 150	25	150	

Rete di protezione per cuccette

Rete provvista di corda elastica
con cappio per il fissaggio sulle
cuccette.
Completa di 4 ganci terminali.
Confezione in busta singola.

Protection net for caravan beds

Synthetic net provided
with rubber rope.
For fastening on bunk beads.
With 4 ends hooks.
Single packing in polybag.

Articolo - Article	Lunghezza rete - Net length mt.	gr.	€/pc.
Z 00 00 220	2 x 0,60 H	335	



Scala profilo 35x20mm Ladder 35x20mm profile

S4506028
S4505128



art. 451841611 ▶ **Sfuso - Bulk**
€/pc.

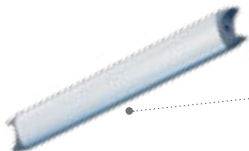

art. G3135023 ▶ **Sacchetto singolo**
Single polybag
€/pc.

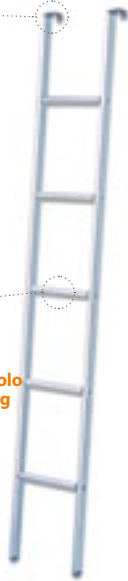

Scala profilo Ø 25mm Ladder Ø25mm profile

S4305160



art. 454379025 ▶ **Sfuso - Bulk**
€/pc.



Scala profilo 35x20mm Ladder 35x20mm profile

S3026148



art. 451842050 ▶ **Sfuso - Bulk**
€/pc.



art. 451842047 ▶ **Sfuso - Bulk**
€/pc.



Attacco autoportante per scale profilo 35x20mm



art. 451850250 ▶ **Sfuso - Bulk**
€/pc.

Attacco per scale profilo 50x25mm



art. 451841817 ▶ **Sfuso - Bulk**
€/pc.

Tappo per scale profilo 35x20mm



art. 454135000 ▶ **Sfuso - Bulk**
€/pc.



made by
trem

Piedino snodato per scale cuc- cetta

Confezione da 1 kit composto da 2 piedini snodati con ventosa e tubetto.

Articolo - Article
S 20 25 721

Articulated foot for bunk bed ladders

Packing of 1 kit composed by 2 articulated feet with suction cap and tube.

Profilo - Profile
Ø 35mm.

€/Kit



Attacchi scale cuccetta

Fabbricati in nylon.
Provisti di viti per il fissaggio.
Confezione in sacchetto da 1 paio.

Articolo - Item
S 20 35 020

Wall supports for bunk ladders

Made of nylon.
Supplied with fixing screws.
Packing: bag of 1 pair.

Al paio - Pair



Portapacchi e scale esterne

Roof accessories and ext. ladders

Profilo tondo Round profile - Ø 25 mm

►Mod. Largo

►Mod.Large



►Mod.Stretto

►Mod.tight



Scalette fisse attacco a parete con gradini piatti antisdrucciolo

Complete di attacchi per il montaggio. Confezione in sacco singolo.
Tubo Ø 25 mm.

Fixed aluminium ladders wall mounting with antislip flat steps

Supplied with mounting kit. Single packing in bag.
Pipe Ø 25 mm.

Scalette fissa 5 gradini per camper e motorhome

Attacco a parete
Complete di attacchi per il montaggio.
Confezione in sacco singolo.
Tubo Ø 25 mm.

Foldind ladders 5 steps for camper and caravan

Wall mounting
Supplied with mounting kit. Single packing in bag.
Pipe Ø 25 mm.

Articolo - Item	Gradini - Steps	Larghezza Width cm.	Lunghezza Length cm.	gr.	€/pc.
S 41 28 005	5	28	150	2800	
S 41 28 006	6	28	180	3200	

Articolo - Item	Gradini - Steps	Larghezza Width cm.	Lunghezza Length cm.	gr.	€/pc.
S 41 25 005	5	21	150	2800	

Ricambi

Spare parts



art. 03125003 ►Tubo - Pipe 25 x 1,5 x 3 m
€/pc.



art. S3007060 ►1 paio - 1 pair
€/Paio-Pair



art. 454379025 ►Sfuso - Bulk
€/pc.



art. 0S3200222
►Sfuso - Bulk
€/pc.



art. 451860410 ►1 paio - 1 pair
€/Paio-Pair



art. S2025060 x tubi Ø 25 mm.
►6 pezzi - 6 pcs
€/pc. €/Box



art. S4240627
►1 paio - 1 pair
€/Paio-Pair



art. 00030031 x tubi Ø 25-30 mm.
►Sfuso - Bulk
€/pc.



art. S2004065 x tubi Ø 25 mm.
►1 paio - 1 pair
€/pc.



Portapacchi e scale esterne

Roof accessories and ext. ladders

Profilo ovale Oval profile - 35 x 20 mm

► H 150 mm

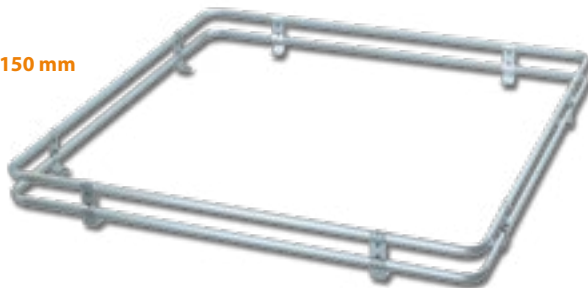

Portapacchi serie ovale a doppio profilo altezza 150 mm. senza rastrelliera indicati per camper e roulotte

Fabbricato in alluminio anodizzato argento. Completo di 8 supporti, 8 curve e 8 tubi. Confezione singola completa di chiavi e istruzioni per il montaggio.

Tubo ovale Ø 35 x 20 x 1,5 mm.

Roof luggage rack, with double oval profil in anodised aluminium, without central rack, height 150 mm. for camper and caravan

Made of silver anodised aluminium. Supplied with 8 supports, 8 curves, 8 pipes. Single packing, complete with keys and installations instructions.

Oval pipe Ø 35 x 20 x 1,5 mm.

Articolo - Article	↑ cm.	📦 gr.	€/pc.
O 04 15 220	220 x 220	7900	

► H 150 mm



Portapacchi serie ovale altezza 150 mm. senza rastrelliera indicati per camper e roulotte

Fabbricato in alluminio anodizzato argento. Completo di 6 supporti, 2 curve e 3 tubi. Confezione singola completa di chiavi e istruzioni per il montaggio.

Tubo ovale Ø 35 x 20 x 1,5 mm.

Roof luggage rack in anodised aluminium, without central rack, height 150 mm. for camper and caravan

Made of silver anodised aluminium. Supplied with 6 supports, 2 curves, 3 pipes. Single packing, complete with keys and installations instructions.

Oval pipe Ø 35 x 20 x 1,5 mm.

Articolo - Article	↑ cm.	📦 gr.	€/pc.
O 04 13 290	220 x 220	4000	

Scale esterne - External ladders 35 x 20



240/230 cm

Scala pieghevole 8 e 10 gradini per camper e motorhome «serie Ovale»

Nuovo modello di scala pieghevole con gradini a doppia pedata. Di forma gradevole con possibilità di attacco sulla parete posteriore del camper. Fabbricata in tubo di alluminio estruso con snodi in nylon. Confezione singola con istruzioni per il montaggio. Larghezza 28 cm.

Tubo ovale Ø 35 x 20 mm.

Folding ladder 8 and 10 steps for camper and motorhome «Oval series»

New model of folding ladder with double tread steps. Well-shaped with possibility to be fastened to the rear wall of the camper. Made of extruded aluminium pipe with nylon joints. Packing in single bag with mounting instructions. Width 28 cm.

Oval pipe Ø 35 x 20 mm.

Articolo - Article	Gradini - Steps	Lunghezza - Length cm.	📦 gr.	Modello - Model	€/pc.
S 46 00 007	8	230	4800	Anodizzato Anodised	
S 56 00 009	10	240	5000	Verniciato bianco White painted	

Ricambi Spare parts



► Sfuso - Bulk

Articolo - Article	€/pc.
450035250	



► 1 paio - 1 pair

Articolo - Article	Larghezza - Width mm.	€/Paio-Pair
S 20 35 020	20	



art. 0S2079061
► 1 paio - 1 pair
€/Paio-Pair



S4600007

made by TREM

art. G3135023 ► Sfuso - Bulk
€/pc.



art. 451841631 ► Sfuso - Bulk
€/pc.



art. S2035130
► 1 paio - 1 pair
€/Paio-Pair



Portapacchi - Roof racks



art. S2035150
► 1 paio - 1 pair
€/Paio-Pair

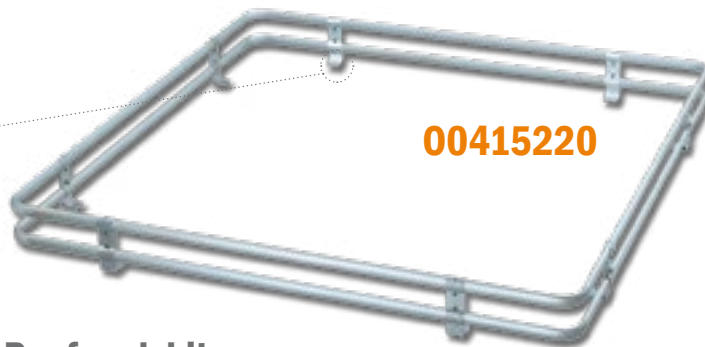

00415220

Kit piano di carico - Roof rack kit



Basi per barre di carico

Confezione in sacchetto da 10 pezzi

Articolo - Article	Lunghezza - Length mm.	Altezza - Height mm.	€/pc.	€/box
S 20 41 630	60	25		

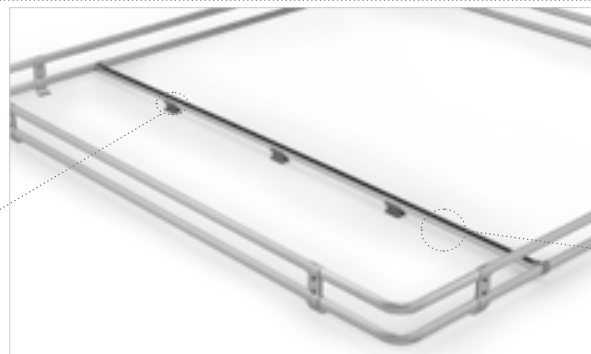

Supports for racks

Packing in polybag of 10 pcs.



Barra di carico

Confezione in sacchetto da 1 kit

Articolo - Article	Kit completo - Complete kit	€/Kit
O 00 35 022	1 profilo da 2,2 mt. - 2 raccordi - 1 guaina PVC 1 pole 2,2 mt. - 2 connections - 1 PVC gasket	

Rack for luggage rack

Packing in polybag of 1 kit.



Portapacchi e scale esterne

Roof accessories and ext. ladders

Profilo ovale Oval profile - 50 x 25 mm

Scale esterne - External ladders 50 x 25



made by TREM

ARTICOLO PRESENTE SUI MEZZI

ADRIA

Scala esterna 6 gradini in alluminio

In tubo di alluminio.
Confezione singola.

External ladder 6 steps alloy

Made of aluminium
Single packing.

Articolo - Article	Larghezza Width cm.	Gradini - Steps	Lunghezza Length cm.	gr.	€/pc.
S 30 26 160	30	6	170	2500	
S 30 26 166	30	6	166	2500	

Portapacchi 50 x 25 - Roof rack 50 x 25

made by TREM

ADRIA



Portapacchi serie super ovale 50 x 25 mm. ad un profilo con copripiedi

Composto da tre barre, due angolari e due terminali in materia plastica.

Le barre sono inoltre provviste di 5 supporti alu.

Confezione singola completa di chiavi e istruzioni per il montaggio.

Single profile roof rack for camper with super oval 50 x 25 mm., «U» shape model «Quarter Moon»

New model provided with three bars, two tapered oval bends and two nylon end fittings.

The bars are equipped with 5 Alu supports.

Single packing complete with keys and installation instructions.

Articolo - Article	cm.	Altezza - Height cm.	€/pc.
O 30 31 257	258 x 210	13	
O 30 31 285	285 x 210	13	



made by TREM

Kit barre portapacchi ovale 50 x 25 mm. con copri supporti in plastica

Fabbricato in tubo di alluminio anodizzato 50 x 25 mm.

Composto da 2 barre da 240 cm., da 4 piedi in alluminio e 4 copripiedi in plastica.

Confezione in scatola da 2 barre e accessori.

Bars kit oval roof rack 50 x 25 mm. support covers in plastic

Made of anodised aluminium pipe 50 x 25 mm.

Composed by 2 bars of 240 cm., 4 aluminium supports and 4 plastic covers.

Packing in box of 2 bars and accessories.

Articolo - Article	Lunghezza - Length cm.	Altezza - Height cm.	€/Kit
O 30 11 246	240	10	

Ricambi Spare parts



03013205



art. 451860204
▶ 1 Paio - 1 Pair
€/Paio-Pair

ARTICOLO PRESENTE SUI MEZZI



03011246



art. S3060566
€/Paio-Pair

▶ 1 paio - 1 pair

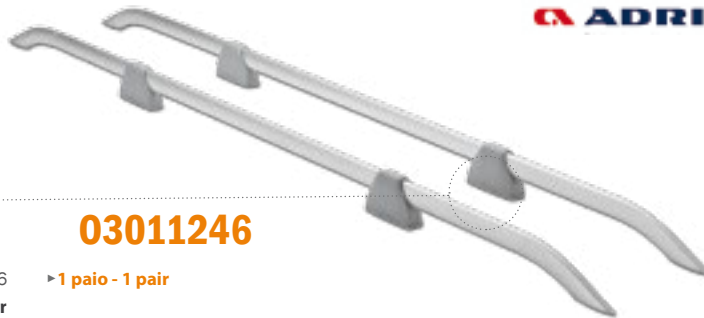

Ricambi Scale esterne - Spare parts External ladders 50 x 25



art. 451842047
▶ Sfuso - Bulk
€/pc.



13 cm

art. S3041975
▶ 1 paio - 1 pair
€/Paio-Pair



art. 451842053
▶ Sfuso - Bulk
€/pc.



13 cm

art. 03013160
▶ 1 pezzo - 1 pc.
€/pc.



art. 451830110 **Grigio - Grey**
▶ Sfuso - Bulk
€/pc.



art. 457430110 **Bianco - White**
▶ Sfuso - Bulk
€/pc.



art. 0S2079061
▶ 1 paio - 1 pair
€/Paio-Pair



A

€/Kit
€/pc.



B

art. OP1842049 A - su esterna - external
art. 451842050 B - su cuccetta - bunk bed
▶ 1 pezzo sfuso - 1 pc. bulk

RICAMBI - SPARE PARTS





Barre per piano di carico complete Bars for roof rack

Confezione in sacca da 1 kit.

Packing in polybag of 1 kit

Articolo - Article	Kit composto da - kit made up of	€/Kit completo - Full kit
O 30 50 022	1 barra da mt. 2,20 - 1 pole 2,20 mt. 2 innesti laterali - 2 side joints 3 appoggi di rinforzo - 3 supports	

Appoggio per rastrelliera piano di carico

Confezione in scatola sfusa.

Support for luggage rack

Bulk packing.

Articolo - Article	Lunghezza - Length mm.	Altezza - Height mm.	€/pc.
451850007	3	100 x 50	



Lamiera di rinforzo per tetto camper e motorhome

Fabbricata in alluminio.

Confezione da 1 lastra sfusa.

Stiffening plate for the roof of camper and caravan

Made of aluminium.

Packing: 1 plate in bulk.

Articolo - Article	Spessore - Thickness mm.	cm.	gr.	€/pc.
S 20 35 050	3	100 x 50	2850	



Kit composto da 2 barre 50 x 25 per fissaggio piano di carico

Confezione in sacca da 1 kit.

2 bars kit 50 x 25 for fixing of roof rack

Packing in polybag of 1 kit.

Articolo - Article	Lunghezza - Length mt.	Kit	€/kit completo 2pz. - Whole kit 2 pcs.
O 30 25 003	3	2 barre da 3 mt. - 2 bars 3 mt. + terminali laterali - side brackets	

Asta porta antenne per tubi Ø 25mm. - Antenna holder pole for pipes Ø 25mm.



Asta telescopica porta antenna per applicazione alla scala del camper

In tubo di alluminio anodizzato. Munita di morsetto e completa di attacchi.

Confezione in sacchetto singolo.

Telescopic antenna support rod for application to the camper ladder

Made of anodized aluminium pipe. Provided with clamp and connections.

Single packing in polybag.

Articolo - Item	Telescopico - Telescopic mm.	€/pc.
L 31 25 200	1100 - 2000	

Portabici e garage

Cycle-holder and garage



Schema Portabici e optional Trem - Cycle-holder layout & Trem optional

Con nuovi braccetti
New arms



Culle disassabili
Off-axis cradles



Portaculle INOX
SS cradle holder



Nuove culle con nuovi cinghietti
New cradles with new belts



Descrizione	Elnagh	Major 100-150	Major 40-50	Laika	Garage	Ducato	Caravan
Articolo	O1202405G	O1202553GR	O1202493GR	O0280493GR	O0202090GR	O1502215	O0090499
Per veicolo	Camper	Camper	Camper	Camper	Camper	Ducato	Caravan
Applicazione	Parete Posteriore	Parete Posteriore	Parete Posteriore	Parete Posteriore	Garage	sportello Posteriore	Timone
Portata bici	2/4	2/4	2/4	2/3	2/3	2	2
Peso kg./Portata kg.	10/60	8/60	7,5/60	5,5/50	4,5/50	14/40	5/35
bracci 1° bici O0030070	●	●	●	●	●	●	●
bracci 2° bici T3126270	●	●	●	●	●	●	●
bracci 3° bici T3140370	●	●	●	●	●	●	●
bracci 4° bici T3150470	●	●	●	●	●	●	●
bracci 1° bici T3101018	●	●	●	●	●	●	●
bracci 2° bici T3102032	●	●	●	●	●	●	●
bracci 3° bici T3103045	●	●	●	●	●	●	●
bracci 4° bici T3104057	●	●	●	●	●	●	●
culla 125 c/term. O0001125	-	-	-	-	-	●	●
cinghietto con nottolino 1C0000490	4 ●	●	●	●	●	●	2 ●
cinghietto 1C0000550	●	●	●	●	●	●	2 ●
cinghietto con cricchetto C3580030	●	4 ●	4 ●	4 ●	4 ●	4 ●	●
€/pc.,							

► **LEGENDA:** Di serie ● optional ●



- Applicazione a timone
- Modello inclinabile che consente l'apertura del gavone



Portabici mod. «Caimano Light» indicato per montaggio al timone di roulotte e caravan adatto per 2 biciclette

Cycle holder mod. «Caimano Light» for caravans suitable for 2 bikes

Fabbricato in tubo di alluminio anodizzato.
Tubo Ø 30 mm.
Confezione singola con istruzioni per il montaggio.

Made of anodized aluminium pipe.
Pipe Ø 30 mm.
Single packing with installation instructions.

Articolo - Article	Colore - Colour	Altezza - Height cm.	Culle - Rails cm.	kg.	€/pc.
O 00 30 499 GR		75	125	4,0	

Portabici SEA-Elnagh - SEA-Elnagh Cycle holder

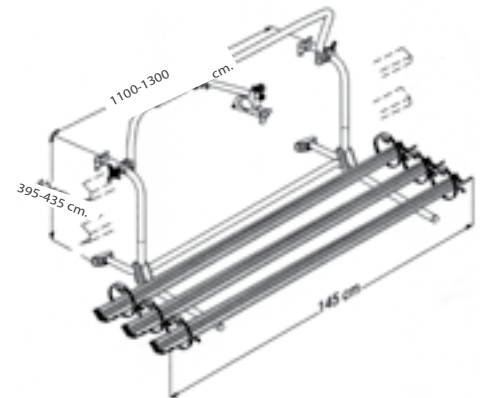

Grazie ai kit riduzione può essere applicato a tutti gli attacchi in commercio



Portabici telescopico applicabile su tutti i mezzi «Elnagh Sea».
Supporto culle in acciaio inox Aisi 316

Cycle holder telescopic suitable for all «Elnagh Sea» vehicles.
Rail-holder in stainless steel Aisi 316

Confezione in scatola singola.

Single packing in box.

Articolo - Article	Colore - Colour	Modello - Model	€/pc.
O 12 02 405 GR		2 bici - 2 bikes	
O 12 03 403 GR		Kit 3a bici con cingh. - Kit 3rd cradle w/belt	



Con nuovi braccetti
New arms

60 cm

80-150
cm

«Major» Line MAXI

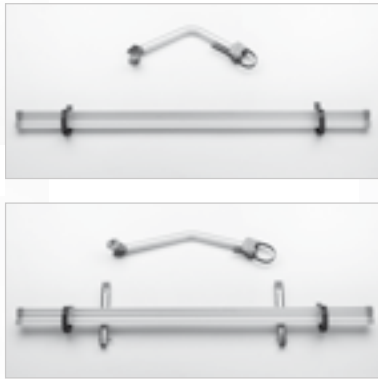

Portaculle INOX
SS cradle holder



Portabici maxi Serie Major. Modello telescopico,
altezza 80-150 cm.

Fabbricato in alluminio anodizzato.
Portata massima 50 kg.
Completo di attacchi.
Completo di un braccio fermabici e un cinghietto.
Tubo Ø 30-35 mm.
Confezione in scatola singola.

Maxi cycle-holder Major serie. Telescopic model,
height 80-150 cm.

Made of anodised aluminium.
Maxi load 50 kg.

Complete with fastening bar and a belt.
Pipe Ø 30-35 mm.
Packing in a single box.

Articolo - Article	Colore - Colour	Modello - Model	Culle - Rails cm.	Larghezza - Width cm.	Altezza - Height cm.	€/pc.
O 02 02 553 GR		2 bici - 2 bikes	125	60	80-150	
O 04 00 493 GR		Kit terza bicicletta - Kit 3rd cycle	125	-	-	
O 04 04 493 GR		Kit quarta bicicletta - Kit 4th cycle	125	-	-	

Culle disassabili
Off-axis cradles



Ideale per 4 bici
Suitable for 4 bikes



Con nuovi braccetti
New arms

60 cm

40-50 cm

«Major» Line MINI



Portaculle INOX
SS cradle holder



Portabici maxi Serie Major. Modello telescopico,
altezza 40-50 cm.

Fabbricato in alluminio anodizzato.
Portata massima 50 kg.
Completo di attacchi.
Completo di un braccio fermabici e un cinghietto.
Tubo Ø 30-35 mm.
Confezione in scatola singola.

Maxi cycle-holder Major serie. Telescopic model,
height 40-50 cm.

Made of anodised aluminium.
Maxi load 50 kg.

Complete with fastening bar and a belt.
Pipe Ø 30-35 mm.
Packing in a single box.

Articolo - Article	Colore - Colour	Modello - Model	Culle - Rails cm.	Larghezza - Width cm.	Altezza - Height cm.	€/pc.
O 02 02 493 GR		2 bici - 2 bikes	125	60	40-50	
O 04 00 493 GR		Kit terza bicicletta - Kit 3rd cycle	125	-	-	
O 04 04 493 GR		Kit quarta bicicletta - Kit 4th cycle	125	-	-	

Culle disassabili
Off-axis cradles



Ideale per 4 bici
Suitable for 4 bikes

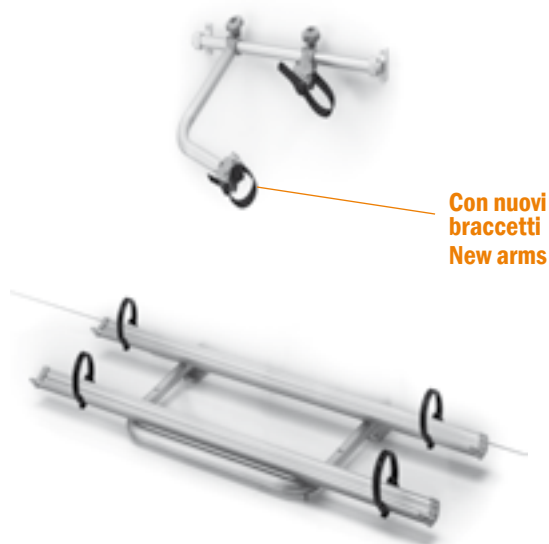

Con nuovi braccetti
New arms



Culle disassabili
Off-axis cradles



Portabici pieghevole per Garage con mensola fissata a parete

Modello completo di attacchi a parete.
Completo di braccio e di 1 cinghietto.
Tubo Ø 30 mm.
Confezione in scatola singola.

Telescopic Garage serie with fixed shelf

Model complete with wall fastening.
Complete with fastening bar and a belt.
Pipe Ø 30 mm.
Packing in a single box.

Articolo - Article	Colore - Colour	Modello - Model	Culle - Rails cm.	€/pc.
O 02 02 090 GR		2 bici - 2 bikes	125	
O 04 00 493 GR		Kit terza bicicletta - Kit 3rd cycle	125	



Maniglione a barra per garage

Realizzato in alluminio anodizzato.
Confezione da 1 kit in sacchetto.

Big bar handle for camper garage

Made in anodised aluminium.
Packing of 1 kit in polybag.



Articolo - Article	mm.	€/Kit
N 43 30 600	600	

Ideale per utilizzo con braccetti fermabici pag.27
Ideal for utilization with cycle fastening bars page 27

Portabici «Ducato»

S.S. Cycle holder «Ducato»

Con nuovi
braccetti
New arms

Portaculle INOX
SS cradle holder

Culle disassabili
Off-axis cradles



«Ducato»



Portabici Ducato

Fabbricato in alluminio anodizzato.
Portata massima 60 kg.
Completo di un braccio fermabici e un cinghietto.
Tubo Ø 30-35 mm.
Confezione in scatola singola.

Articolo - Article	Colore - Colour	Modello - Model	Culle - Rails cm.	Larghezza - Width cm.	Altezza - Height cm.	€/pc.
O 15 02 215		2 bici - 2 bikes	125	80	40-50	

SI MONTA DIRETTAMENTE SENZA FORARE IL MEZZO

Ducato Cycle-holder

Made of anodised aluminium.
Maxi load 50 kg.
Complete with fastening bar and a belt.
Pipe Ø 30-35 mm.
Packing in a single box.

Portabici «Laika» tubo maggiorato inox Ø30-35mm.

S.S. Cycle holder «Laika» Line pipe Ø30-35mm.

Con nuovi
braccetti
New arms



Portaculle INOX
SS cradle holder

Culle disassabili
Off-axis cradles



Ideale per 4 bici
Suitable for 4 bikes



Portabici Laika grigio tr.80, altezza 40-50 cm., larghezza 80cm.

Fabbricato in alluminio anodizzato.
Portata massima 60 kg.
Completo di un braccio fermabici e un cinghietto.
Tubo Ø 30-35 mm.
Confezione in scatola singola.

Articolo - Article	Colore - Colour	Modello - Model	Culle - Rails cm.	Larghezza - Width cm.	Altezza - Height cm.	€/pc.
O 02 80 493 GR		2 bici - 2 bikes	125	80	40-50	

Maxi cycle-holder Major serie. Telescopic model, height 40-50 cm.

Made of anodised aluminium.
Maxi load 50 kg.
Complete with fastening bar and a belt.
Pipe Ø 30-35 mm.
Packing in a single box.



Accessori per portabici serie «Trotter New» - Accessories for «Trotter New» bike-holder



Culla portabici con terminali e cinghietti

Confezione da 1 kit completo.

Articolo - Article	Colore-Color	Lunghezza - Length cm.	€/Kit
O 00 12 125		125	
O 00 79 145		145	

Cradle for cycle with end fittings and belts

Packing of 1 whole kit.



Terminali culle

Confezione sfusa.

Articolo - Article	Colore-Color	Modello - Model	€/pc.
451880102		Standard	
451870102		Standard	

End fittings for rail

Bulk packing.



Cinghietti con cricchetto

Confezione in sacchetto da 1 paio.

Articolo - Article	€/Paio - Pair
C 35 80 030	

Belt with latch

Packing in polybag of 1 pair.



Cinghietto con nottolino

Confezione sfusa e sacchetto da 10 pezzi.

Articolo - Article	Fibbia	€/pc.	€/box
C 35 15 047	Zama		

Belt

Bulk packing and in polybag of 10 pcs.



Pomelli

Confezione in sacchetto da 10 pezzi.

Articolo - Article	Modello - Model	€/pc.	€/box
O 00 06 155	Maxi		

Knobs

Packing in polybag of 10 pcs.



Cinghietto

Confezione sfusa e sacchetto da 10 pezzi..

Articolo - Article	Fibbia	€/pc.	€/box
C 35 15 046	Zama		
C 35 15 045	Plastica		

Belt

Bulk packing and in polybag of 10 pcs.

Ricambi Spare parts



Bracci fermabici con doppio bloccaggio a morsetto e a cinghietto con clips

In alluminio anodizzato.
Con cinghietto in nylon regolabile.
Confezione in sacchetto da 1 kit.

Cycle fastening bars with double safety bike holders and belt with clips

Manufactured in anodised aluminium.
With adjustable nylon belt.
Packing in polybag of 1 kit.

Articolo - Article	Lunghezza - Length cm.	Adatto per - Suitable for	€/Kit
O 00 30 070 GR	15	A-1 bici - 1 cycle	
T 31 26 270 GR	26	B-2 bici - 2 cycles	
T 31 40 370 GR	40	B-3 bici - 3 cycles	
T 31 50 470 GR	50	B-4 bici - 4 cycles	



Bracci fermabici con bloccaggio di sicurezza

Fabbricati in alluminio anodizzato
Confezione in sacchetto da 1 kit.

Cycle fastening bars with safety bike holders

Manufactured in anodised aluminium.
Packing in polybag of 1 kit.

Articolo - Article	Lunghezza - Length cm.	Adatto per - Suitable for	€/Kit
T 31 01 018	18	C-1 bici - 1 cycle	
T 31 02 032	32	C-2 bici - 2 cycles	
T 31 03 045	40	C-3 bici - 3 cycles	
T 31 04 057	47	C-4 bici - 4 cycles	



Morsetti fermabici

Confezione in sacchetto da 1 kit.

Easy bike block

Packing in polybag of 1 kit.

Articolo - Article	Mod.	€/pc.
O 00 25 000	D	

Attacchi a parete brevettati indicati per tubo ø 30 mm.

Fabbricati in nylon caricato.
Completo di viti.
Confezione in sacchetto da 1 kit completo.

Patented wall attachments suitable for pipe ø 30 mm.

Made of reinforced nylon.
Complete with screws.
Packing in polybag of 1 whole kit.

Articolo - Article	Mod.	€/Kit
V 12 02 407 N	F	



Riduzione per applicazione portabici Tr.Em.

Sui mezzi in commercio.
Confezione singola.

Adaptor for Tr.Em. Cycle-holder

On means of transport in the market. Bulk packing.

Articolo - Article	Mod.	€/pc.
450785578	G	



Copribici - Bike cover



made by
TREM



Copribici impermeabile e completo di tasca per pannello carichi sporgenti

Confezione singola.

Bike cover and complete with pocket for exceeding loads panel

Single packing.

Articolo - Article	Modello - Model	€/pc.
O 00 75 161	2/3 biciclette con tasca - 2/3 bicycles with pocket	
O 00 75 181	4 biciclette con tasca - 4 bicycles with pocket	

* I modelli con tasca (B) **non sono provvisti** di pannello carichi sporgenti

* Models with pocket (B) **are not supplied** with exceeding load panels



A



B



C

Pannelli per «Carichi sporgenti»

Confezione in sacchetto singolo.

Approved panel for «Exceeding loads»

Single packing in polybag.

Articolo - Article	Tipo - Type	Dimensioni - Size cm.	Modello - Model	Conf. pz. - Box pcs.	€/pc.	€/box
D 39 20 020	A	50 x 50	Conforme - Conforming	5		
D 39 50 050	B	50 x 50	Omologato - Homologation	10		
C 07 05 055	C	Corda elastica per fissaggio pannelli-Elastic Cord for fastening of exceeding load		4		

Portasci - Ski rack

► Fissaggio a cinghia
► Belt fixing



made by
TREM

Portasci per veicoli fuoristrada facile applicazione alla ruota di scorta con robuste cinghie munite di tensionatore

Doppia regolazione, in altezza per adattare gli attacchi degli sci e in larghezza per adattarsi allo spessore della ruota. Rastrelliera portasci con chiave antifurto.

Tubo Ø 30 mm. in alluminio anodizzato

Confezione singola con istruzioni per il montaggio.

Telescopic ski rack for multi-purpose motor vehicles spare wheel fastening with special adapter and central screw

It is provided with connections equipped with antitheft devices for every ski. Equipped with anti-theft key.

Pipe Ø 30 mm. in anodised aluminium

Single packing.

Articolo - Article	Altezza telescopica Telescopic height cm.	gr.	€/pc.
O 02 05 754	120 - 140	6500	



Blocchi fermasci

Ideali per 4 sci oppure per 2 sci e 4 snowboard. Confezione al paio.

Ski-fitting blocks

Suitable to carry 4 ski or 2 ski and 4 snowboards. Packing in a pair.

Articolo - Article	€/Paio - Pair
456203600	

Rampa garage - Garage ramps

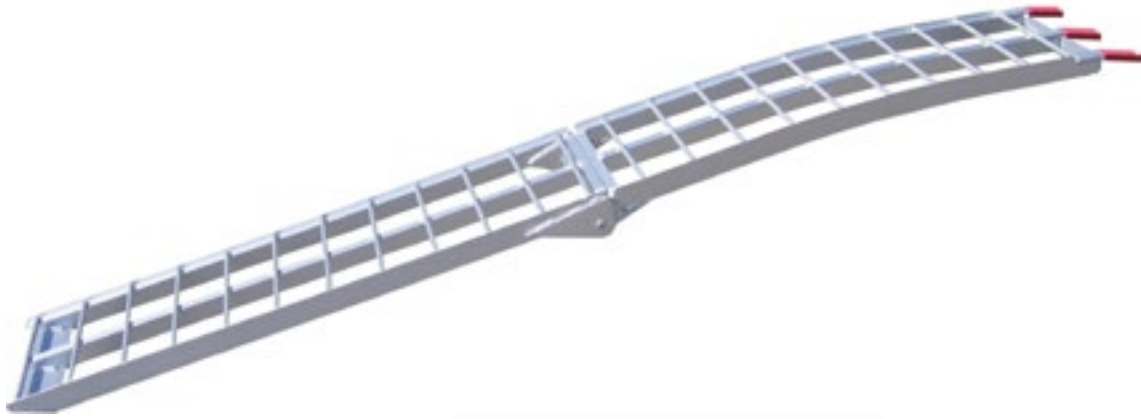

Rampa pieghevole in alluminio per garage

Confezione in scatola singola e in box da 5 pezzi.

Folding garage ramp

Single packing and in box of 5 pcs.

Articolo - Article	Lunghezza - Length cm.	Portata - Load kg.	€/pc.
O 33 90 095	220	350	

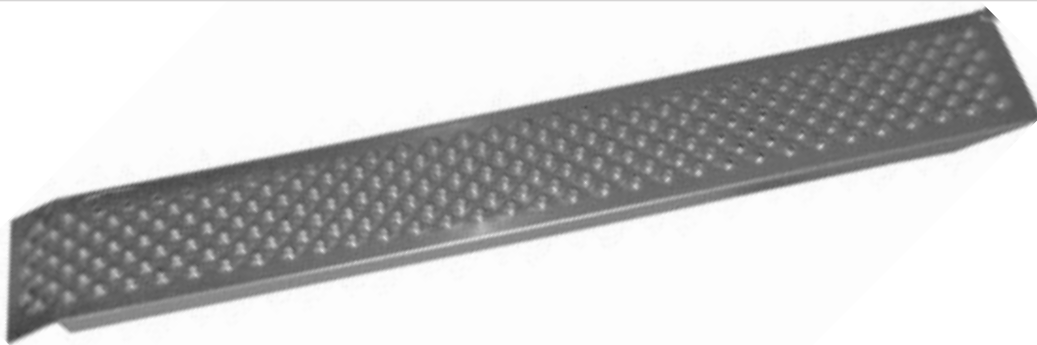

Rampa fissa in alluminio per garage

Confezione in scatola singola e in box da 5 pezzi.

Aluminium steady garage ramp

Single packing and in box of 5 pcs.

Articolo - Article	Lunghezza - Length cm.	Portata - Load kg.	€/pc.
O 33 90 090	150	200	

Barre garage - Garage Bars



Coppia barre fermabicli per garage con occhioli regolabili

Confezione completa di 2 barre di alluminio anodizzato complete di 10 golfari regolabili da applicare alle pareti del garage. Confezione da 1 kit in sacchetto.

Pair of fixing bars for cycles to the camper garage with adjustable hooks

Kit of 2 bars in anodised aluminium with 10 adjustable eyelets for mounting on wall.

Packing of 1 kit in polybag.

Articolo - Article	cm.	€/Kit
O 00 35 020	200	



Accessori da esterno Outdoor accessories



Serrature - Door locks



A



B



Serratura tonda per porta

Serratura destra con cilindro e coppia di chiavi.
Confezione singola in sacchetto.

Baggage door lock

Right hand lock with cylinder and key set.
Single packing in polybag.

Articolo - Article	Tipo - Type	Colore - Colour	€/pc.
N 28 19 031	A	Nero - Black	
N 28 19 133	B	Bianco White	



A



B

Serratura push per portellone

Con pulsante girevole
manovrabile a mano con rotore e coppia di chiavi.
Confezione singola in sacchetto.

Door push lock

With revolving push-button.
Complete with rotor and key set.
Single packing in polybag.

Articolo - Article	Tipo - Type	Colore - Colour	€/pc.
N 28 19 035	A	Nero - Black	
N 28 19 128	B	Bianco White	



Serratura quadrata per sportello

Con coperchio antipolvere. Con rotore e coppia di chiavi.
Confezione singola in sacchetto.

Door square lock

With dustproof cover. With rotor and key set.
Single packing in polybag.

Articolo - Article	Colore - Colour	€/pc.
N 28 19 038	Nero - Black	

Alzapagliolo - Lifting ring

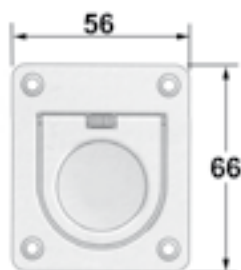

Alzapagliolo in acciaio inox Aisi 316

In sacchetto da 6 pezzi.

Lifting ring in stainless steel Aisi 316

Packing in polybag of 6 pcs.

Articolo - Article	€/pc.
N 30 56 066	



Fermaporta in materiale plastico Plastic doorstop

Confezione in sacchetto da 20 pezzi. Packing: in polybag of 20 pcs.

Articolo - Article	Colore - Colour	€/Kit
N 28 24 005	Bianco - White	



Serratura in plastica per portine Lock in plastic for doors

Movimento 180° con rotore e coppia di chiavi. 180° movement with rotor and key set.
Confezione singola in sacchetto. Single packing in polybag.

Articolo - Article	€/pc.
N 28 19 041	



Coppia di chiavi + cilindro Key set + lock cylinder

Colore di serie nero. Standard black colour.
Confezione da 1 kit in sacchetto. Packing: 1 kit in polybag.

Articolo - Article	€/Kit
N 28 00 166	



Chiave estraotore Extractor key

Confezione singola in sacchetto. Single packing in polybag.

Articolo - Article	€/pc.
N 28 30 109	

Maniglie - Handles



Maniglia alza pagliolo Flush handle

Articolo - Item	mm.	Colore - Colour	€/pc.
N 30 44 033	L 57 x H 57 x Ø 44	■ Crema-Cream 9010	
N 30 44 074	L 57 x H 57 x Ø 44	□ Bianco-White 9003	
N 30 44 080	L 57 x H 57 x Ø 44	■ Nero-Black	



Fermaporta in ottone Brass door lock

Fabbricato in ottone cromato. Manufactured in chromed brass.

Articolo - Item	kg.	€/pc.
Z 43 00 165		



Appendiabiti in ottone cromato Chromed brass coat hook

Articolo - Item	mm.	€/pc.	€/box
M 35 20 038	20 x 38		



Scrochio in acciaio inox Aisi 316 Latch in Aisi 316 stainless steel

Articolo - Item	mm.	kg.	€/pc.
M 35 25 028	25 x 28 x 37 H	0,050	
M 35 38 035	38 x 35 x 38 H	0,100	



**Aeratore da appoggio rettangolare in materiale plastico**

Confezione in sacchetto da 6 pezzi.

Rectangular vent made of plastic material

Packing in polybag of 6 pcs.

Articolo - Article	Modello - Model	↓ mm.	€/pc.	€/box
Z 22 23 081	Con zanzariera - with mosquito net	230 x 80		



A



B

Prese d'aria quadrato**Square air vents**

Articolo - Item	Mod.	Colore - Colour	Passaggio aria - Air vent mm ²	↓ mm.	pz.-pcs.	€/pc.	€/box	kg.
Z 22 33 118	A	Crema-Cream	5000	118x118	5		*	
Z 22 74 118	A	Bianco-White	5000	118x118	5			
Z 22 79 118	A	Grigio-Grey	5000	118x118	5		*	
Z 22 80 118	A	Nero-Black	5000	118x118	5		*	

Prese d'aria rettangolari**Rectangular air vents**

Articolo - Item	Mod.	Colore - Colour	Passaggio aria - Air vent mm ²	↓ mm.	pz.-pcs.	€/pc.	€/box	kg.
Z 22 33 206	B	Crema-Cream	8000	206x106	5		*	
Z 22 74 206	B	Bianco-White	8000	206x106	5			
Z 22 79 206	B	Grigio-Grey	8000	206x106	5		*	
Z 22 80 206	B	Nero-Black	8000	206x106	5		*	

**Aeratore a fungo**

Aeratore permanente con possibilità di fissaggio senza forare il soffitto. Spessore da 22 a 55 mm. Passaggio d'aria minimo 28 cm. Zanzariera e copriviti incorporati. Colore di serie avorio. Confezione in sacchetto singolo.

**Mushroom vent**

Fixed ventilation mushroom. Can be fitted with no holes in the ceiling. Thickness 22 -55 mm. Free air flow 28 cm. Mosquito net and screw cover included. Ivory standard colour. Single packing in polybag.

Articolo - Article	€/pc.
Z 22 22 002	

* Disponibile su richiesta per quantità- Available on request for qty

Tendine oscuranti - Sunset curtains

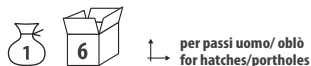

Tendine oscuranti «Sunset Curtain» complete di gancio d'arresto

Con telaio in acciaio inox verniciato con resine epossidiche. Molle in acciaio inox. Tessuto oscurante in poliesteri, con lato esterno metallizzato argento al fine di garantire di notte oscuramento totale e di giorno la riflessione dei raggi solari. Si montano sotto i passi uomo o davanti agli oblò.



Awning blind «Sunset Curtain» complet with locking hook

Frame made in stainless steel, painted with epoxy powder. Springs in stainless steel. Easy mounting under the manholes or in front of the portholes.



A

Articolo - Article	← max.	Fori Holes mm.	↳ telo-fabric mm.	€/pc.
V 25 40 360	450	410	360 x 440	
V 25 50 450	540	500	450 x 540	
V 25 60 500	590	550	500 x 640	
V 25 65 550	640	600	550 x 680	
V 25 78 680	770	730	680 x 810	
V 25 37 970	975	935	870 x 300	
V 25 58 130	1350	1310	1260 x 530	
V 25 74 045	A - Gancio di ricambio - Spare hook			

Griglie d'aerazione in acciaio inox - Stainless steel ventilators

Griglie di areazione

Fabbricate in acciaio inox lucidato. Ideali per cabine e vani motore.

Air ventilators

Manufactured in polished stainless steel.



Articolo - Item	↳ mm.	€/pc.	↳ kg.
Z 22 12 115	127 x 115		0,120



Coprisfiati e prese d'aria

Modelli in acciaio inox.

Air ventilators

Manufactured in stainless steel.

Articolo - Item	↳ mm.	↳ pcs.	€/pc.	€/box	↳ kg.
Z 22 40 045	45 x 40 x 12 H	10			0,090
Z 22 54 057	57 x 54 x 16 H	6			0,090
Z 22 87 093	93 x 87 x 25 H	6			0,300



Griglie di areazione per cabina o vano motore

Fabbricate in acciaio inox.

Cabin ventilators

Manufactured in stainless steel.



Articolo - Item	↳ mm.	€/pc.	↳ kg.
Z 22 04 003	115 x 230		0,160



Griglia di areazione tonda

Fabbricata in acciaio inox.

Round ventilator

Manufactured in stainless steel.



Articolo - Item	Ø mm.	€/pc.	↳ kg.
Z 22 23 026	130/120		0,070



Griglia di areazione a farfalla

Fabbricata in acciaio inox Aisi 316/304.

Adjustable ventilator

Manufactured in stainless steel Aisi 316/304.



Articolo - Item	Ø mm.	€/pc.	↳ kg.
Z 22 23 028	125		0,100





«Midi Steppy»

made by 



Espositore con 12 gradini milleusi confezionati in gradevole confezione espositore

Fabbricato in materiale termoplastico rinforzato.
Confezioni da 12 pezzi, colore grigio.

Display stand with 12 multi-purpose steps designed with pleasant display package

Made of reinforced thermoplastic material.
Packing: 12 pcs. grey colour

Articolo - Article

€/Espositore 12 pz. - Display stand 12 pcs.

Z 36 00 000



made by 

Gradino per camper in Moplen rinforzato

Fabbricato in materiale termoplastico rinforzato.
Consigliamo di utilizzare i nostri picchetti Art. H 07 00 120, per ottenere una maggiore stabilità durante l'uso.
Confezione sfusa in pallets da 120 pezzi.

Steps made of reinforced polypropylene

Made of reinforced thermoplastic material.
We recommend Art. H 07 00 120. to get a higher stability during use.

Bulk packing in pallets of 120 pcs.

Articolo - Article

Colore Colour

↳ cm.

📦 gr.

€/pc.

Z 36 79 140

Grigio - Grey

H 23 x 43 x 28

990



Gradino pieghevole

Fabbricato in lamiera tropicalizzata
Confezione sfusa.

Folding step

Made of tropicalised sheet metal.
Bulk packing.

Articolo - Article

↳ cm.

€/pc.

Z 36 60 826

H 40 x 48 x 36

Gradini mod. «Big» - Steps mod. «Big»



mod. «Big»



Espositore con 12 gradini milleusi colore grigio «Big Steppy»

Gradini in Moplen rinforzato.

Confezioni da 12 pezzi.

Display stand with 12 multi-purpose grey colour steps «Big Steppy»

Steps made of reinforced Moplen.

Packing: 12 pcs.

Articolo - Article

€/Espositore 12 pz. - Display stand 12 pcs.

Z 36 00 235

A norma Europea EN1645-1646

In accordance with european rule EN1645- 1646

- Omologato 200 kg.
- Homologation 200 kg.

BIG STEPPY



Nuovo gradino serie «Big Steppy» colore grigio

Realizzato in Moplen rinforzato. Consigliamo di utilizzare i nostri picchetti art. H0700120 per ottenere una maggiore stabilità durante l'uso.

Confezione sfusa in pallet da 120 pz.

New step «Big Steppy» series grey colour

Made of reinforced Moplen. It is suggested to use our pegs art. H0700120 to get more stability when in use.

Bulk packing in pallets of 120 pcs.

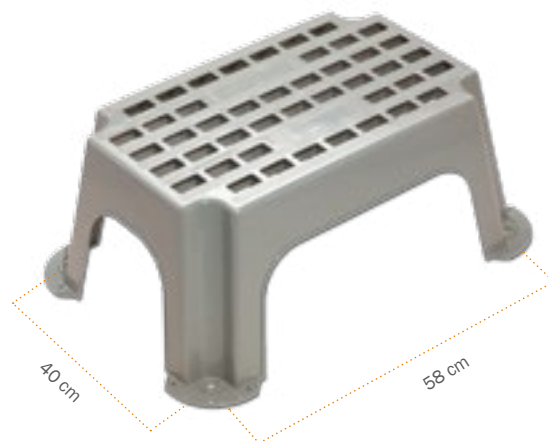

Articolo - Article

cm.

gr.

€/pc.

Z 36 79 235

H 23,5 x 58 x 40

1250

Serie martinetti - Axle stands

mod. «Extra»



Serie 4 martinetti di stazioneamento regolabili in materiale antiurto adatti per camper e roulotte mod. «Ursus»

Portata 900 kg. cadauno. Fabbricati in lega leggera e plastica. Colore nero. Confezione in scatola da 4 pezzi.

Set of standing holders, 4 pcs. made of shockproof plastic ideal for camper mod. «Ursus»

Capacity load: 900 kg. each. Made of light alloy and plastic. Black colour. Packing in box of 4 pcs.

Serie 4 martinetti di stazioneamento regolabili in alluminio adatti per camper e roulotte mod. «Magnum»

Portata 1000 kg. cadauno. Fabbricati in lega leggera pressofusa. Confezione in scatola da 4 pezzi.

Set of axle stands, 4 pcs. made of aluminium ideal for camper mod. «Magnum»

Capacity load: 1000 kg. each. Made of light alloy, black colour. Packing in box of 4 pcs.

Articolo - Article

Base Base Ø mm.

Altezza regolabile Adjustable height cm.

€/La serie 4 pz. Series 4 pcs.

Z 21 22 048

215

26 - 46

Articolo - Article

Base Base Ø mm.

Altezza regolabile Adjustable height cm.

€/La serie 4 pz. Series 4 pcs.

Z 21 15 046

156 x 156

30 - 46

**Rubinetto con sfiato**

Per bombole attacco «Italia».

Confezione singola in sacchetto.

Vent tap

For cylinders with «Italy» connector.

Single packing in polybag.

Articolo - Article

L 23 04 900

€/pc.

**Rubinetto con sfiato**

Per bombole attacco «Camping gaz».

Confezione singola in sacchetto.

Vent tap

For cylinders with «Camping gaz» connector.

Single packing in polybag.

Articolo - Article

L 23 04 800

€/pc.

**Rubinetto senza sfiato**

Per bombole attacco «Camping gaz».

Confezione singola in sacchetto.

Tap

For cylinders with «Camping gaz» connector.

Single packing in polybag.

Articolo - Article

L 23 04 700

€/pc.

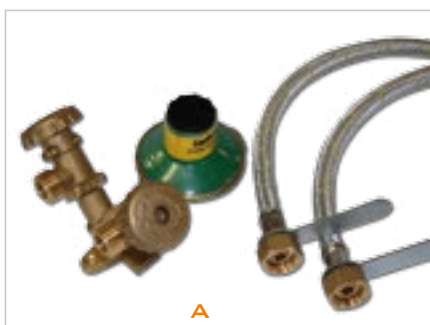
**Mini centralina con regolatore**

Idonea per il collegamento in parallelo di 2 bombole Gpl. Con valvole di accesso di flusso e 2 manichette Flex da 50 cm. Confezione singola in sacchetto.

Mini control unit with controller

Single packing in polybag.

Articolo - Article

L 23 10 302Portata max
Max load

4 kg./h

Taratura variabile
Variable calibration

MBAR 30

Modello
Model

A

€/pc.

L 23 06 228

Raccordo con ogive e ghiere per connettere il kit regolatore

B

Manichetta Flex da 500 mm. con tubo di gomma rivestito da treccia metallica

Per bombole Gpl.

Confezione singola in sacchetto.

Flex hose 500 mm. with wiry-coated rubber pipe

Suitable for Gpl cylinder.

Single packing in polybag.

Articolo - Article

L 23 09 801

€/pc.

**Guarnizione in Salpha**

Per regolatore Gpl.

Confezione in busta da 50 pezzi.

Gasket

For Gpl regulator.

Packing in polybag with 50 pcs.

Articolo - Article

L 23 08 600

€/pc.

**Guarnizione in NBR**

Per regolatore Gpl, gomma nera. Confezione in busta da 50 pezzi.

NBR gasket

For Gpl regulator, black rubber. Packing in polybag with 50 pcs.

Articolo - Article

L 23 08 601

€/pc.



Regolatore gas orizzontale bassa pressione

Omologato IMQ. Entrata: dado 25 mm. attacco «Italia». Uscita: portagomma Ø 10 mm. Confezione singola in sacchetto.

Horizontal gas regulator low pressure

IMQ homologated. In: nut 25 mm. «Italy»-type connector. Out: Hose nozzle Ø 10 mm. Single packing in polybag.

Articolo - Article	Portata max Max load	Taratura fissa Fixed calibration	€/pc.
L 23 00 300	1 kg./h	PU/MBAR 30	



Regolatore verticale bassa pressione

Omologato IMQ. Entrata: dado 25 mm. attacco «Italia». Uscita: portagomma Ø 10 mm. Confezione singola in sacchetto.

Vertical regulator low pressure

IMQ homologated. In: nut 25 mm. «Italy»-type connector. Out: Hose nozzle Ø 10 mm. Single packing in polybag.

Articolo - Article	Portata max Max load	Taratura fissa Fixed calibration	€/pc.
L 23 00 301	1 kg./h	PU/MBAR 30	



Regolatore orizzontale bassa pressione

Omologato IMQ. Entrata: dado 25 mm. attacco «Italia». Uscita: portagomma Ø 10 mm. Confezione singola in sacchetto.

Horizontal regulator low pressure

IMQ homologated. In: nut 25 mm. «Italy»-type connector. Out: Hose nozzle Ø 10 mm. Single packing in polybag.

Articolo - Article	Portata max Max load	Taratura regolabile Adjustable calibration	€/pc.
L 23 00 500	1,0 kg./h	Regolabile PU/MBAR 20-60	



Regolatore bassa pressione attacco «Camping gaz»

Uscita: portagomma Ø 10 mm. Confezione singola in sacchetto.

Low pressure regulator «Camping gaz» connection

Out: Hose nozzle Ø 10 mm. Single packing in polybag.

Articolo - Article	Portata max Max load	Taratura variabile Variable calibration	€/pc.
L 23 00 400	0,8 kg./h	Variabile PU/MBAR 28-50	



Regolatore bassa pressione attacco «Camping gaz»

Uscita: portagomma Ø 10 mm. Confezione singola in sacchetto.

Low pressure regulator «Camping gaz» connection

Out: Hose nozzle Ø 10 mm. Single packing in polybag.

Articolo - Article	Portata max - Max load	Taratura fissa - Fixed calibration	€/pc.
L 23 00 402	0,8 kg./h	PU/MBAR 30	



Rubinetto d'inversione manuale per bombole Gpl

Con attacco «Italia». Confezione singola in sacchetto.

Hand inversion tap for Gpl cylinder

«Italy»-type connector. Single packing in polybag.

Articolo - Article	€/pc.
L 23 15 000	

**Raccordo di riempimento**

Per bombole da campeggio attacco «Italia».
Confezione singola in sacchetto.

For cylinders with «Italy» connector.
Single packing in polybag.

Articolo - Article

L 23 12 400

€/pc.

**Indicatore del livello del gas Propano/Butano nelle bombole**

Con attacco magnetico.
Ideale per bombole da 2 a 5 kg.
Confezione singola in sacchetto.

Level gauge

With magnetic connector.
For cylinders 2 - 5 kg.
Single packing in polybag.

Articolo - Article

L 23 00 049

€/pc.

**Chiave per regolatore**

Con dado da 25 mm.
attacco «Italia».
Confezione singola in sacchetto.

Regulator key

With nut 25 mm.
«Italy» connector.
Single packing in polybag.

Articolo - Article

L 23 11 100

€/pc.

**Raccordo ottone femmina**

Confezione singola in sacchetto.

Female brass joint

Single packing in polybag.

Articolo - Article

L 23 07 300

Modello - Model

Bombola Italia per maschio
bombola tedesca A

L 23 07 301

Bombola Tedesca per maschio
bombola Italia B

€/pc.

**Tubo Gpl Ø 8 x 13 mm. IMQ**

Confezione in rotolo da 100 m.

Gpl hose Ø 8 x 13 mm. IMQ

Packing in reel of 100 m.

Articolo - Article

L 23 08 502

€/Rotolo - Reel

**Bombola 400 ml.**

Per rivelazione fughe di gas.
Confezione singola in sacchetto.

Cylinder 400 ml.

For gas leak detection.
Single packing in polybag.

Articolo - Article

L 23 22 503

€/pc.

**Indicatore di livello per bombole da campeggio**

Con attacco «Italia».
Confezione in sacchetto singolo.

Level gauge for gas cylinder da campeggio

«Italy»-type connector.
Single packing in polybag.

Articolo - Article

L 23 00 050

€/pc.

Sicurezza - Safety items

Gilet alta visibilità

A norme EAN 8009257110700.
Obbligatorio in caso di sosta.

High visibility jacket

In compliance with
EAN 8009257110700.
Compulsory when the car
stops.
Packing in polybag.

Confezione in sacchetto.

Articolo - Article	Colore - Colour	Modello - Model	€/pc.
B 28 70 319	Arancio - Orange	Standard	4,84



Triangolo di sosta «Omologato Europa»

Triangolo obbligatorio per la
sosta dei veicoli.
Completo di astuccio a norme
europee.
Confezione in contenitore
singolo.

Warning triangle «EC Homologation»

Compulsory warning triangle
for vehicles.
Provided with approved case.
Single packing in case.

Articolo - Article	cm.	€/pc.
D 39 34 038	47 x 47	



Cassetta di pronto soccorso «Mini»

Completa di una dotazione di
presidi di medicazione.
Contenitore fabbricato in Abs
con cerniere dai due lati, dotato
di supporto per il fissaggio a
parete. Pronto soccorso di primo
intervento.

First aid kit «Mini»

For first aid situations.
Box manufactured in Abs with
hinges on both sides.
Suitable for wall mounting.

Confezione singola.

Single packing.

Articolo - Article	cm.	€/pc.
D 13 12 018	13 x 18 x 7 H	



Estintore antincendio kg. 1 «Omologato Rina»

Modello funzionante con cartuc-
cia di CO2 sigillata.
Modello ricaricabile.
Provvisto di supporto per
l'ancoraggio a parete.

Powder fire extinguisher kg. 1 Ps1-XN ABC

It runs with CO2 sealed
cartridge. Rechargeable mo-
del. The luminous safety strip
ensures a better identification
at night, fastens the fire
extinguisher to the support.
Packing in box of 12 pcs.

Confezione: scatola da 12 pezzi.

Articolo - Article	Classe - Type	Modello - Model	€/pc.
E 00 13 020	34B - C	Normale - Normal	A
E 00 01 008	8A - 34B - C	Con manometro - With manometer	B



Livella a piramide

Modello a doppia scala orizzon-
tale e verticale.
Confezione singola.

Pyramid level

Horizontal and vertical double
scale.
Single packing.

Articolo - Article	€/pc.
N 20 41 214	



«Livella - Level»

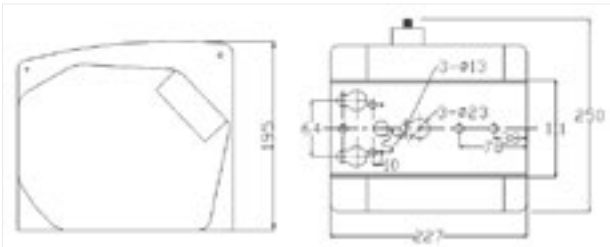
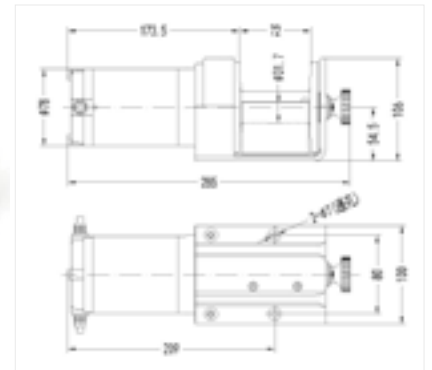
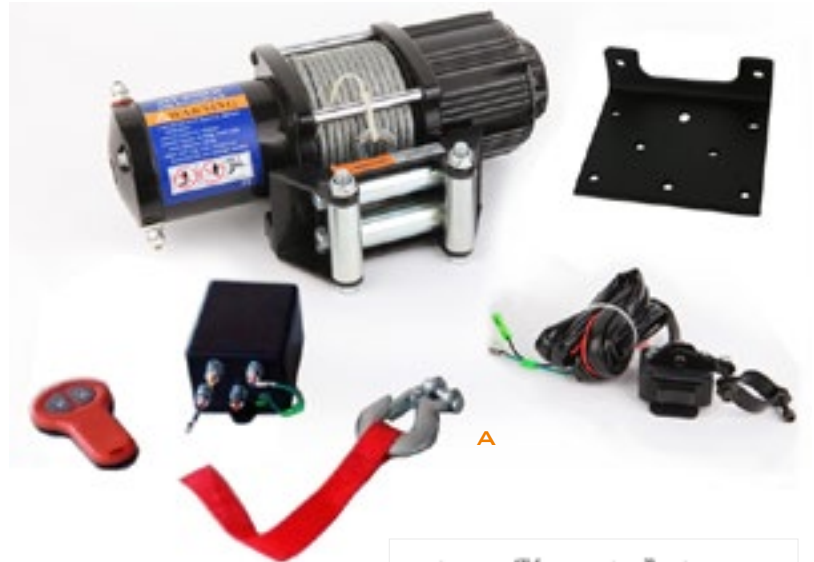
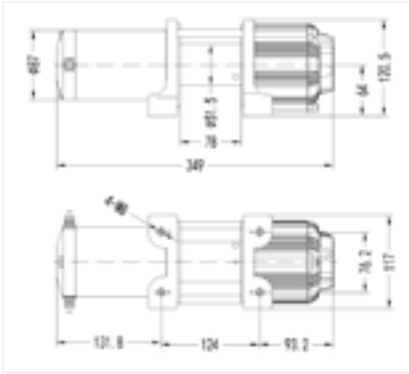

CON CONTROLLO REMOTO
WITH REMOTE CONTROL



Argani elettrici

Ideali per alaggio imbarcazioni, carico autovetture su camion, trattati con particolari procedimenti anti corrosione. Alimentazione a 12V. con marcia avanti, indietro, fermo.

Electrical winches

With traction gear in steel. With forward, neutral and reverse gear. Supply: 12V.

Articolo - Item	Motore Engine W.	Rapporto Ratio	Modello Model	Telecomando di ricambio Spare remote control	Amp.	HP	Cavo Cable Ø mm. x L mt.	↳ mm.	⊞ kg.	€/pc.
N 08 32 113	800	166:1	A	-	278	1,3	5,5 x 15,2	351 x 117 x 120	15,000	
N 08 12 153	530	258:1	B	1N0802153	90	1	4 x 7,6	285 x 105 x 105	5,000	
N 08 12 464	450	464:1	C	1N0802464	40	0,4	5 x 9	240 x 254 x 190	17,000	

PORTATA MAX
MAXI LOAD

Modello Model	↕ Traino barca su carrello Boat pulling on trailer kg.	↕ Traino barca in acqua Boat pulling in water kg.	↕ Traino barca su terreno kg. Boat pulling on the ground kg.
A	5400	5000	1800
B	2720	2270	900
C	2720	2270	900

Argani manuali - Hand operated winches



Serie argani manuali idonei per cavetto in acciaio N0448750

In acciaio zincato. Ingranaggi in acciaio temperato e cuscinetti autolubrificanti. Marcia indietro e folle ad azionamento rapido.

Trailer winches suitable for steel cable N0448750

In galvanized steel. Gears in tempered steel. Reverse and neutral quick operating.

Articolo - Item	kg.	Demoltiplica Gear ratio	mm.	pz.	kg.	€/pc.
N 08 00 027	350	3.2:1	80 x 120	6	1,800	
N 08 00 045	450	4:1	140 x 88	6	2,800	
N 08 00 065	540	4:1	140 x 88	6	2,800	
N 08 00 063	630	4:1	140 x 88	6	3,900	
N 08 00 120	900	4:1/10:1	185 x 120	4	4,750	
N 08 00 125	1125	5:1/12:1	200 x 120	4	4,800	

DOPIA VELOCITA' DOUBLE SPEED

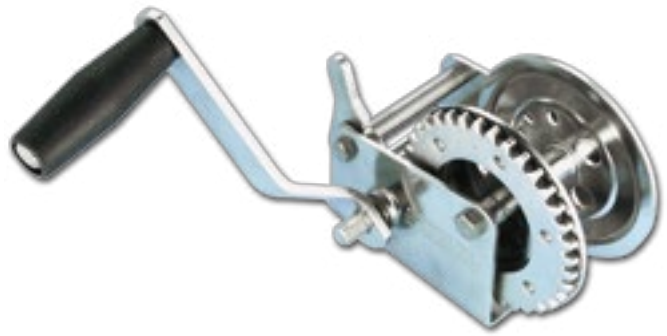

Serie argani manuali idonei per cavetto e cinghia pag.41

In acciaio verniciato nero. Ingranaggi in acciaio temperato e cuscinetti autolubrificanti. Marcia indietro e folle ad azionamento rapido.

Trailer winches suitable for steel cable page 41

Black painted. Gears in tempered steel. Reverse and neutral quick operating.

Articolo - Item	kg.	Demoltiplica Gear ratio	mm.	kg.	€/pc.
N 08 18 647	900	4:1/10:1	190 x 135	2,380	
N 08 17 648	1125	5:1/12:1	190 x 135	2,840	

MODELLO SUPER

DOPIA VELOCITA' DOUBLE SPEED



Accessori e Ricambi Accessories & Spare Parts



Accessori per argani - Accessories for trailer winches



Nastri in nylon per argani completi di moschettone portata 1400 kg.

Indicati per argani manuali. Sostituiscono i tradizionali cavi in acciaio evitando i difetti dovuti all'aggravamento e rottura dei fili.

Trailer winch belt in nylon with snap-hook

Made in Nylon width 50 mm., with snap hook. Avoids problems of twisting.

Articolo - Item	cinghia-belt mm.	cinghia-belt mt.	€/pc.	kg.
C 35 50 750	50	7,5		1,500



Cavo in acciaio per argani completi di moschettone

Trailer winch cable with snap-hook

Articolo - Item	Ø mm.	mt.	€/pc.	kg.
N 04 48 750	4,8	7,5		0,900



**Antifurto per carrello**

Applicabile sul giunto sferico con il carrello sganciato.

Antitheft device for trailer

To be applied on the ball joint when the transport cart is disconnected.

Articolo - Item	Versione	€/pc.	kg.
O 10 00 880	universale		

**Gancio omologato per rimorchio****Type-approved tow hooks, universal version**

Articolo - Item	Canale-Channel Ø mm.	Sfera-Tow ball per carichi fino a		€/pc.	kg.
		Ø mm.	for loads up to kg.		
O 10 50 075	tondo-round 60	50	750		
O 10 50 076	quadro-square 50	50	750		
O 10 60 075	quadro-square 60	50	750		
O 10 50 130	tondo-round 50	50	1300		
O 10 50 137	quadro-square 50	50	1300		
O 10 60 130	quadro-square 60	50	1300		

**Soffietto in gomma per gancio rimorchio****Rubber bellow for hauling hook**

Articolo - Item	Versione - Version	€/pc.	kg.
O 10 00 541	Universale - Universal		

**Copriferza ad incastro**

Pratica, universale e resistente agli agenti atmosferici.

Towing ball joint cover

Practical, universal and weather resistant.

Articolo - Item	Versione - Version	€/pc.	kg.
O 10 00 898	Universale - Universal		

**Barra in plastica con luci al led**

Cavo centrale da 5 m. Fanale dx-sx: posizione, stop, freccia luce targa + triangoli riflettenti.

Plastic bar with LED lights

5 m. central cable. Left/right light: position, stop, direction, immatriculation plate + reflecting triangles.

Articolo - Item	descrizione	€/pc.	kg.
O 10 55 120	barra plastica - plastic bar 120 cm		

**Kit luci a led fissaggio magnetico**

Cavo centrale: 7,5 m a 5 poli, cavo fanale - fanale 2,5 m. Tipo: posizione, stop, freccia, luce targa.

LED light kit magnetic mounting

Central cable: 7,5 m, 5 poles. 2,5 m. cable spotlight to spotlight. Type: position, stop, direction, plate light.

Articolo - Item	Volts	Triangoli riflettenti Reflecting triangles	Spina poli Plug poles	€/pc.	kg.
O 10 07 534	12-24	si	7		

**Supporto per ruotino****Wheel support**

Articolo - Item	Tubo - Hose Ø mm.	Articolo - Item p/ruotino-f/wheel	mm.	€/pc.	kg.
O 10 41 531	35 reg.-adj.	-	54 x 130		
O 10 41 532	48	O 10 48 370			



Fanale d'ingombro

Clearance light

Articolo - Item	Descrizione-Description	Colore	€/pc.	kg.
O 10 00 610	fanale laterale base piana flat base side light	bianco-rosso white-red		
O 10 45 610	fanale laterale base gomma rubber base side light	bianco-rosso white-red		



Fanale posteriore

Rear light

Articolo - Item	Descrizione-Description	Funzione - Function	€/pc.	kg.
O 10 03 550	dx - sx	posizione / stop / direzione position / stop / direction		



Kit luci posteriori

Rear light kit

Cavo centrale: 7,5 m a 5 poli.
Cavo fanale - fanale 2,5 m.
Fanale dx: posizione + stop +
freccia + luca targa
Fanale sx: posizione + stop +
freccia. Spina 7 poli

Central cable: 7,5 m, 5 poles.
Spot light cable 2,5 m.
Right spotlight: position + stop +
direction + numberplate light
Left spotlight: position + stop +
direction. 7-pole plug.

Articolo - Item	Tipo - Type	€/pc.	kg.
O 10 75 052	fissaggio magnetico - magnetic mounting		
O 10 75 034	fissaggio magnetico + triangoli riflettenti magnetic mounting + reflecting triangles		



Catadiottri

Catadioptric lights

Articolo - Item	Modello	mm.	€/pc.	kg.
O 10 70 060	arancione-orange	60		
O 10 74 060	bianco-white	60		
O 10 70 160	arancione adesivo adhesive orange	60		
O 10 74 160	bianco adesivo adhesive white	60		
O 10 03 070	triangolare-triangular	70 (interasse fori bore centre distance)		



Barra posteriore in plastica con luci

Rear plastic bar with lights

Cavo centrale: 5 m a 5 poli.
Fanale dx: posizione + stop +
freccia + luce targa
Fanale sx: posizione + stop +
freccia. Spina 7 poli.
Triangoli riflettenti.

Central cable: 5 m, 5 poles.
Right spotlight: position + stop +
direction + numberplate light
Left spotlight: position + stop +
direction. 7-pole plug.
Reflecting triangles.

Articolo - Item	Descrizione - Description	€/pc.	kg.
O 10 05 120	barra plastica-plastic bar 120 cm		



Fanale a led

LED light

Articolo - Item	Mod.	Volts	Descrizione - Description	Funzione - Function	€/pc.	kg.
O 10 24 404	A	12-24	posteriore dx/sx - right/left rear light	posizione / stop / direzione-position / stop / direction		
O 10 12 004	D	12	fanale posteriore dx/sx a 4 luci 4-light right/left rear light	posizione / stop / direzione / luce targa position / stop / direction / numberplate light		



Fanale a led







LED light

Articolo - Item	Mod.	Volts	Descrizione - Description	Funzione - Function	€/pair	kg.
O 10 24 022	B	12-24	fanale d'ingombro lat. 45°-45° side light	ingombro bianco/rosso - size white/red		
O 10 24 028	C	12-24	fanale d'ingombro lat. 90°-90° side light	ingombro bianco/rosso - size white/red		



		Sfera per gancio traino	Sphere			Gancio traino	Sphere			Lucchetto blocca gancio	Hook locking device		
1		Articolo - Item	Versione - Version	€/pc.	kg.	Articolo - Item	Versione - Version	€/pc.	kg.	Articolo - Item	Versione - Version	€/pc.	kg.
		O 10 10 703	Regolamentare Regulatory			O 10 11 703	A squadra Right angle			O 10 00 268	Universale Universal		

Ruotini per carrelli - Spare wheels for trolleys

			A		B		C		D			
Ruotini d'appoggio										Stern wheels		
Articolo - Item	Mod.	Tube-Pipe Ø mm.		ruota-wheel mm.		Mod. ruota-wheel	kg.	€/pc.				
O 10 41 500	A	35		Ø 160 x 40		Plastica-Plastic	2,870					
O 10 41 501	B	48		Ø 200 x 50		Metallo-Metal	4,490					
O 10 41 503	C	48		Ø 260 x 85		Plastica-Plastic	3,950					
O 10 41 507	D	48		Ø 260 x 85		Metallo-Metal	4,420					

			A		B		C		
Ruote di ricambio per ruotini								Spare stern wheels	
Articolo - Item	Mod.	Ricambio per articolo-Spare wheel for art.		mm.	kg.	€/pc.			
O 10 41 540	A	O 10 41 501		Ø 200 x 50	1,590				
O 10 41 542	B	O 10 41 503		Ø 260 x 85	1,140				
O 10 41 543	C	O 10 41 507		Ø 260 x 85	1,300				

Ruote di ricambio - Spare wheels

		A		B		C		D		E		F		G			
Ruote di ricambio per carrelli «TR.EM.»															Stern wheels for «TR.EM.» trolleys		
Permettono di trattenere il telo copribarca sullo scafo.																	
Articolo - Item	Ruote - Wheels Ø mm.	Foro-Hole Ø mm.	Mod.	Ricambio per articolo Spare wheel for art.		pz	kg.	€/pc.									
O 10 10 000	80	10	A	In gomma-Rubber	-	6											
O 10 15 000	140	15	B	In gomma-Rubber	-	6											
O 10 26 000	260	20	C	Cerchio in nylon con pneumatico Nylon ring with tire	O0836038 - O0826062 O0826110 - O0836260	6											
O 10 40 000	360	25 - 30	D	Cerchio in nylon con pneumatico Nylon ring with tire	O0800080 - O0836062 O0836080 - O0839094 O0836040 - O0836110	6											
O 10 39 000	390	25 - 30	E	Plastica-Plastic	-	Single											
 O 10 26 085	260	20	F	Cerchio in nylon con pneumatico rigido in PU Nylon ring with PU tire	-	6	0,900										
 O 10 36 085	360	25 - 30	G	Cerchio in nylon con pneumatico in PU Nylon ring with PU tire	O0825240	6	1,500										

Cunei di stazionamento - Parking & balancing wedges



► **Peso - Weight 1,5 kg.**



«Grip» system

L'unico cuneo con sistema «GRIP» per maggiore aderenza al terreno.

The only wedge with «GRIP» system for a better gripping capacity.

«Kit level Magnum»

► **Stabilità**

Superficie di appoggio al terreno migliorata per garantire maggiore stabilità.

► **Stability**

Improved ground support surface for a higher stability.



Coppia cunei di equilibratura e stazionamento di caravan su terreni irregolari o in pendenza e sacca per cunei

Corregge i dislivelli da 8-12 cm.
Per dislivelli maggiori si possono sovrapporre due cunei.
Portata 5000 kg.
Confezione in sacchetto da 2 pezzi.

Couple of wedge for balancing and parking caravans on uneven or slopeground and bag for wedges

Corrects the differences in height of 8-12 cm.
Two wedges superposable for higher differences in height.
Load 5000 kg.
Packing in polybag of 2 pcs.

Articolo - Article	Tipo - Type	mm.	€/Paio - Pair
Z 21 20 053	Cunei-Wedges(A)	535 x 220 x 120 h.	
Articolo - Article	Tipo - Type	mm.	€/pc.
Z 21 80 053	Sacca - Bag (B)	Sacca portacunei - Bag for wedge	



NEW

Cuneo di sicurezza

Realizzato in materia plastica.

Safety chock

Made in plastic.

Articolo - Item	mm.	€/pc.	kg.
O 10 90 220	220 x 100 x 90		



**Spina di corrente a 7 poli****PVC plug 7 poles**

Articolo - Item	Modello - Model	€/pc.	kg.
Z 20 05 197	12V.		0,080

**Presca fissa a 7 poli con coperchio** **PVC socket 7 poles with cover**

Articolo - Item	Modello - Model	€/pc.	kg.
Z 20 04 217	12V.		0,080

**Spina di corrente a 13 poli****Plug 13 poles**

Articolo - Item	Modello - Model	€/pc.	kg.
Z 20 01 013	12V.		0,140

**Presca fissa a 13 poli con coperchio****Socket 13 poles with cover**

Articolo - Item	Modello - Model	€/pc.	kg.
Z 20 12 013	12V.		0,100

**Microadattatore****Microadaptor**

Spina 13 poli + presa 7 poli 12V. 13 pins, 7 plugs. 12V.

Articolo - Item	Modello - Model	€/pc.	kg.
Z 20 40 403	12V.		0,080

**Adattatori di corrente per carrelli****Adaptor for boat carrier**

Articolo - Item	Tipo Type	Modello - Model	€/pc.	kg.
Z 20 13 007	A	da spina a 13 poli a presa 7 from pin 13 poles to plug 7		0,120
Z 20 07 013	B	da spina a 7 poli a presa 13 from pin 7 poles to plug 13		0,070

**Cavo prolunga rimorchio****Extension cable for trailer**

Articolo - Item	←→ mt.	Versione - Version	€/pc.	kg.
O 10 07 005	4,5	presa volante 7 poli + spina 7 poli 7-pole socket + 7-pole plug		
O 10 07 007	6	presa volante 7 poli + spina 7 poli 7-pole socket + 7-pole plug		
O 10 07 010	9	presa volante 7 poli + spina 7 poli 7-pole socket + 7-pole plug		
O 10 27 005	4,5	2 spine 7 poli - 2x7-pole plugs		
O 10 27 007	6	2 spine 7 poli - 2x7-pole plugs		
O 10 27 010	9	2 spine 7 poli - 2x7-pole plugs		
O 10 13 005	4,5	2 spine 13 poli - 2x13-pole plugs		
O 10 13 007	6	2 spine 13 poli - 2x13-pole plugs		
O 10 13 010	9	2 spine 13 poli - 2x13-pole plugs		



Accessori da interno Indoor accessories



Fermapiatti e fermalibri - Stopper for dishes and books



► Si monta senza forare
► No hole mounting system

Fermapiatti e libri

Innovativo fermapiatti multiuso. Ideale per bloccare piatti, libri, ecc. durante i vostri viaggi. Supporto in alluminio e maniglia in plastica resistente. Completo di biadesivo. Confezione in sacchetto singolo.

Stopper

Innovative multi-purpose holder. Ideal for keeping plates and items in place as you travel. Support made in aluminium and handle in sturdy plastic. With double-sided tape. Single packing in polybag.

Articolo - Article	mm.	€/pc.
Z 08 25 200	250 x 200	



Maniglie tientibene - Hand rails

Maniglia tientibene

Modello fabbricato in alluminio. Confezione in sacchetto singolo.

Hand rail

Made in anodised aluminium. Single packing in polybag.

Articolo - Article	Materiale Material	mm.	Interasse viti Interax screws mm.	€/pc.
N 43 33 600	Alluminio anodizzato Anodised aluminium	590	520	



Maniglia tientibene

Modello fabbricato in alluminio anodizzato con terminali in plastica antiurto. Confezione in sacchetto singolo.

Hand rail

Made in anodised aluminium end fittings in shockproof plastic. Single packing in polybag.

Articolo - Article	Colore terminale Colour of holders	Lunghezza Length mm.	Interasse viti Interax screws mm.	€/pc.
N 43 31 400	Grigio - Grey	400	360	
N 43 31 550	Grigio - Grey	590	550	



Maniglia tientibene

Fabbricato in plastica morbida antiurto completa di copriviti. Finitura molto accurata.

Hand rail

Screw-cover included. Made of shockproof soft plastic with screw-cover. Very nice finishing. Packing in polybag of 4 pcs.

Confezione in sacchetto da 4 pezzi.

Articolo - Article	Colore terminale Colour of holders	Lunghezza Length mm.	Altezza - Height mm.	Interasse viti Interax screws mm.	€/pc.
N 38 74 246	Bianco-White	215	55	160	
N 38 79 246	Grigio - Grey	215	55	160	



Maniglia tientibene

Fabbricata in plastica antiurto completa di copriviti. Confezione da 4 pezzi.

Hand rail

Made of shockproof plastic with screw-cover. Packing of 4 pcs.

Articolo - Article	Colore - Colour	Lunghezza Length mm.	Interasse viti Interax screws mm.	€/pc.
N 38 79 250	Grigio - Grey	250	160	



IDEALE PER TELEFONI E
GPS VECCHIA GENERAZIONE

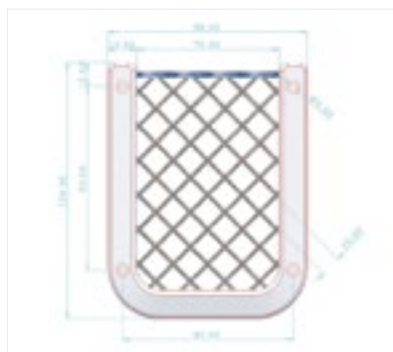

Rete portacellulare e palmare

Cornice in Abs UV Resistant.
Rete in poliestere.

Rectangular elastic net as phone-holder

Frame manufactured in UV resistant Abs.
Net in polyester.

Articolo - Item	Colore - Colour	↳ mm.	€/pc.	kg.
N 17 74 126	□ Bianco-White	126 x 98		0,030
N 17 80 126	■ Nero-Black	126 x 98		0,030

BIG MODEL

IDEALE PER IPHONE ANCHE
MODELLI PLUS

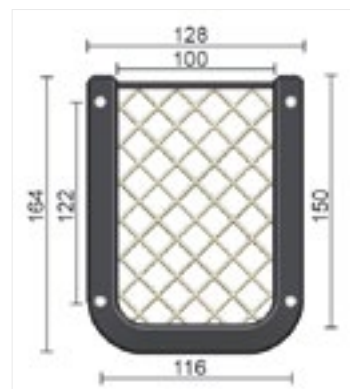

Rete portacellulare e palmare

Cornice in Abs UV Resistant. Rete in poliestere.

Net to carry mobile phone and palm

Frame made of UV Resistant Abs. Net in polyester.

Articolo - Article	Colore - Colour	↳ mm.	€/pc	kg.
N 17 74 164	Bianco-White	150 x 100		
N 17 80 164	Nero-Black	150 x 100		



Mini retina elastica con cornice in plastica

Colore nero.



Mini elastic net with plastic frame

Black colour.

Articolo - Article	↳ cm.	€/pc	kg.
N 17 80 017	15 x 8		



Rete porta-oggetti con cornice

Plastic object-holder

Articolo - Item	Colore - Colour	mm.	€/pc.	kg.
Z 00 74 370	□ Bianco-White	180 x 365		0,390
Z 00 18 370	■ Nero-Black	180 x 365		0,390



Tasca portaoggetti con retina in gomma

Rectangular elastic net in rubber as object-holder

Articolo - Item	Colore cornice - Frame colour	Colore retina - Net colour	mm.	€/pc.	kg.
Z 00 74 115	□ Bianco-White	□ Bianco-White	270 x 115 x 32		0,210
Z 00 80 115	■ Nero-Black	■ Nero-Black	270 x 115 x 32		0,210

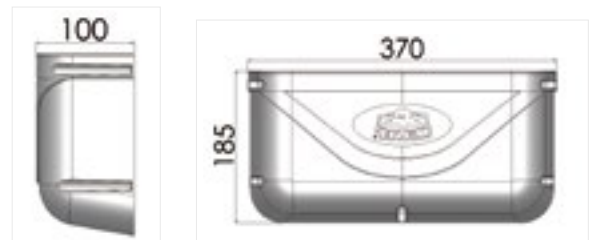

Tasca portaoggetti in ABS con e senza retina

Object-holder pocket made of ABS with or without net

Articolo - Item	Foto - Picture	Colore - Colour	Modello - Model	€/pc.	kg.
D 10 74 370	A	□ Bianco-White	Tasca a parete-Wall pocket		0,400
D 10 18 370	B	■ Nero-Black	Tasca a parete-Wall pocket		0,400



PRIVI DI ATTACCHI (SI CONSIGLIA L'USO DEGLI ATTACCHI A2100020)
WITHOUT FITTINGS (WE SUGGEST THE FITTINGS A2100020)



A2100020



Rete di carico e contenimento colore nero

Load and containment net black colour

Articolo - Item	cm.	pz.	€/pc.	€/	kg.
Z 00 80 114	90 x 35	24		-	
A 21 00 020	Ganci in nylon - Nylon hooks	50			



PRIVI DI ATTACCHI A PARETE (SI CONSIGLIA L'USO DEI BOTTONI)
WITHOUT BUTTONS (WE SUGGEST THE BUTTONS)



N5810004



Rete di carico elastica con bande di contenimento colore nero

Load elastic net with containment bands black colour

Articolo - Item	cm.	pz.	€/pc.	€/	kg.
Z 00 80 040	40 x 25	48		-	
N 58 10 004	Bottoni in acciaio inox mod. maschio Stainless steel press buttons mod.male	200			



PRIVI DI ATTACCHI (SI CONSIGLIA L'USO DEGLI ATTACCHI A2100020)
WITHOUT FITTINGS (WE SUGGEST THE FITTINGS A2100020)



A2100020



made by 

Reti elastiche rettangolari porta oggetti con ganci di attacco

Elastic net to carry various objects

Tessuta a rete con treccia di fibra sintetica. Con dette reticelle ogni spazio nelle imbarcazioni può essere razionalmente sfruttato quale ripostiglio degli oggetti più disparati.

Net manufactured in string of unalterable synthetic material. Supplied all around with a rubber cord and 4 nylon hooks.

Articolo - Item	mm.	pz.	€/pc.	€/	kg.
Z 00 00 150	300 x 200	50		-	0,200
Z 00 00 200	400 x 200	100		-	0,250
Z 00 00 280	700 x 400	50		-	0,380
A 21 00 020	Ganci in nylon - Nylon hooks	50			



Contenitore pieghevole porta scarpe

Studiato appositamente per riporre le scarpe in maniera funzionale. Realizzato in materiale impermeabile. Facilmente appendibile a porte o pareti.

Folding rack for shoes

Specifically designed to store shoes or ropes. Manufactured in waterproof material. Very easy to put on doors or wall.

Articolo - Item	mm.	€/pc.	kg.
D 10 84 054	840 x 540 x 20		1,000



Contenitore pieghevole per bagno

Studiato per essere appeso in spazi ridotti e fungere da armadietto a ripiani. Chiuso svolge la funzione di una normale trousse. Realizzato in materiale impermeabile.

Folding bag for bathroom

Specifically designed to be hanged in small rooms or to serve as a wardrobe. Manufactured in waterproof material.

Articolo - Item	mm.	€/pc.	kg.
D 10 30 037	Aperto-Open: 300 x 1180 x 110 Chiuso-Closed: 300 x 370 x 110		0,500



Portaoggetti verticale

Composto da 11 tasche.

Vertical object holder

Composed by 11 pockets.

Articolo - Item	cm.	Numero tasche Pockets	€/pc.	kg.
D 10 11 084	47 L x 80 H.	11		0,500



Portaoggetti orizzontale

Composto da 6 tasche.

Horizontal object holder

Composed by 6 pockets.

Articolo - Item	cm.	Numero tasche Pockets	€/pc.	kg.
D 10 06 039	87 L x 38 H.	6		0,500



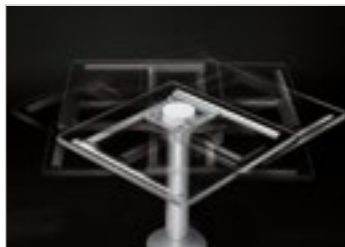

Supporto tritelescopico per tavoli completo di slitta

Fabbricata in lega leggera anodizzata, consente di traslare il piano orizzontalmente e verticalmente in un movimento orbitale. Non è necessario effettuare scassi nel pavimento. Confezione in scatola singola.

Tritelescopic support for tables with slide

Made of anodised light alloy. Telescopic support for table adjustable in 3 different heights with all directions slide. No holes on the floor are required. Single packing in box.

Articolo - Article

O 14 32 720

Altezza - Height mm.

320 ÷ 720

€/pc.

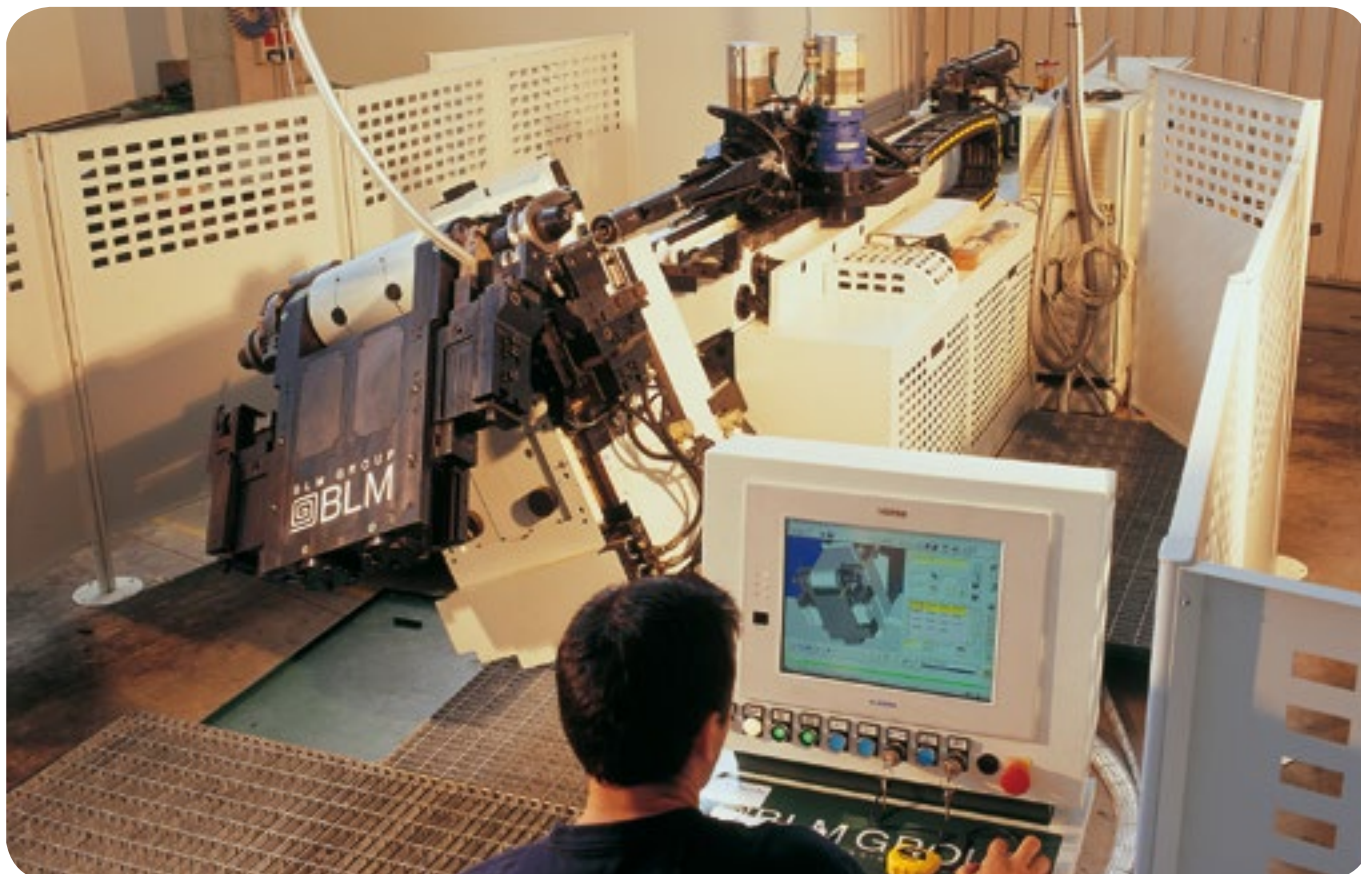

LA TR.EM. PRODUCE QUALITÀ - TR.EM. PRODUCES QUALITY

Supporti tavoli - Table supports

Base ad incasso rinforzata

Per tubo Ø 60 mm.
Realizzata in fusione di alluminio.
Ideale per tubi conificati a pag.
52 del Catalogo Nautica 2010.

Confezione singola.

Articolo - Article	Modello - Model	Ø esterno outer Ø mm.	per tubo for pipe Ø mm.	€/pc.
D 17 74 110	Bianco - White	120	60	

Cast aluminium table supports

For pipe Ø 60 mm.
Made of die - cast aluminium.
Suitable both for table, tops
and basis - see page 52
Camping 2010 Catalogue.
Single packing.



Tubi conificati per piede tavolo Ø 60 mm.

In alluminio estruso anodizzato argento.
Confezione in sacchetto singolo
e in scatola da 25 pezzi.

Articolo - Article	Lunghezza - Length cm.	Tipo - Type	€/pc.
D 17 60 060	60	Anodizzato - Anodised	
D 17 60 070	70	Anodizzato - Anodised	

Cone pipes for table foot Ø 60 mm.

Made of silver anodised aluminium.
Single packing in polybag
and in box of 25 pcs.



In alluminio smaltato bianco - White enameled aluminium

Articolo - Article	Lunghezza - Length cm.	Tipo - Type	€/pc.
D 17 74 070	70	Verniciato bianco White painted	
D 17 74 060	60	Verniciato bianco White painted	

Supporti per tubo piede tavolo

Per tubo Ø 60 mm. Fabbricati in
alluminio pressofuso.
Indicati sia per piano tavolo che
per basi.
Confezione in sacchetto singolo
e in scatola da 50 pezzi.

Articolo - Article	Modello - Model	Tipo - Type	€/pc.
D 17 00 155	da incasso - Flush B	Anodizzato - Anodised	
D 17 00 170	da esterno - Ext. A	Anodizzato - Anodised	

Cast aluminium table supports

Made of die - cast aluminium.
Suitable both for table, tops
and basis.
For pipe Ø 60 mm.
Single packing in polybag
and in box of 50 pcs.



In alluminio smaltato bianco - White enameled aluminium

Articolo - Article	Modello - Model	Tipo - Type	€/pc.
D 17 74 155	da incasso - Flush D	Verniciato bianco White painted	
D 17 74 170	da esterno - Ext. C	Verniciato bianco White painted	



Tappo per base tavoli

Fabbricato in plastica.
Confezione da 6 pezzi.

Articolo - Article	Ø mm.	€/Kit
D 17 60 030	60	

Plug for table support

Made of plastic.
Packing of 6 pcs.

Confezione basi + tubo

Confezione composta da 1 tubo
da 70 cm. e dalla base ad
incasso ed esterno.

Confezione da 1 kit in sacchetto.

Kit base and column

Column height 70 cm.
Flush and external base.

Packing in polybag of 1 kit.

Articolo - Article	Tipo - Type	Altezza - Height cm.	€/Kit
D 17 70 079	Anodizzato - Anodised	70	
D 17 70 074	Verniciato bianco - White painted	70	





Molle a gas telescopiche verniciate

Stelo in acciaio cromato Ø 8-10 mm., con tubo verniciato a polveri Ø 18,5 mm. Colore nero. Provvisto di innesto a vite per l'applicazione di attacchi ad occhio sullo stelo. Attacco ad occhio di serie sul tubo. Attacchi ad occhio Ø 8 mm.

Telescopic painted gas springs

Steel chromed shaft Ø 8-10 mm., pipe painted with epoxy powder. Eye fastening. Black colour.

Articolo - Item	←→ aperta-open mm.	←→ chiusa-closed mm.	↕ Kg.	Foro-Hole Ø	Stelo-Rod Ø	€/pc.	kg.
M 35 04 200	200	140	4	8	8		0,120
M 35 09 200	200	140	9	8	8		0,120
M 35 05 244	244	165	5	8	8		
M 35 09 244	244	165	9	8	8		0,140
M 35 08 244	244	160	18	8	8		0,140
M 35 08 280	280	175	8	6	6		0,160
M 35 11 355	355	225	11	8	8		0,290
M 35 08 355	355	225	18	8	8		0,170
M 35 25 355	355	225	25	8	8		0,170
M 35 35 365	365	225	35	8	8		0,180
M 35 50 365	365	225	50	8	8		0,180
M 35 16 355	370	230	16	8	8		0,170
M 35 25 400	400	240	25	8	8		0,220
M 35 20 445	445	265	20	8	8		0,250
M 35 20 536	536	310	20	8	8		0,280
M 35 08 550	550	320	8	8	8		
M 35 12 550	550	320	12	8	8		0,170
M 35 15 550	550	320	15	8	8		
M 35 20 550	550	320	20	8	8		0,290
M 35 29 550	550	320	29	8	8		
M 35 38 550	550	320	38	8	8		0,290
M 35 70 585	585	335	70	8	10		0,310
M 35 20 600	600	350	20	8	8		0,320
M 35 25 600	600	350	25	8	8		0,320
M 35 28 600	600	350	28	8	8		
M 35 08 600	600	350	36	8	8		0,320
M 35 42 600	600	350	42	8	8		
M 35 70 685	685	385	70	8	10		0,360
M 35 25 700	700	400	25	8	8		0,370
M 35 42 700	700	400	42	8	8		0,370
M 35 55 700	700	400	55	8	10		
M 35 50 850	850	490	50	8	10		
M 35 42 900	900	540	42	8	12		1,200
M 35 70 950	950	550	70	8	10		1,300

Molle in acciaio inox Aisi 316 - Stainless steel Aisi 316 gas springs



Molle a gas telescopiche in acciaio inox Aisi 316 con attacchi a «occhio»

Stelo e tubo in acciaio inox, con possibilità di sostituire la testina terminale.

Telescopic gas springs manufactured in Aisi 316 stainless steel with eye fastening

Stainless steel shaft and tube.

Articolo - Item	Mod.	←→ aperta-open mm.	←→ chiusa-closed mm.	Ø Cilindro-Cylinder	↑↓ Kg.	Stelo-Rod Ø	Foro-Hole Ø	€/pc.	kg.
M 36 05 250	A	250	170	18	5	8	8		
M 37 10 250	A	250	170	18	10	8	8		0,140
M 37 18 250	A	250	170	18	18	8	8		0,140
M 36 18 250	A	250	170	18	30	8	8		0,130
M 36 12 355	A	355	225	18	12	8	8		
M 37 18 355	A	355	225	18	20	8	8		0,170
M 37 25 355	A	355	225	18	25	8	8		0,170
M 36 18 355	A	355	225	18	30	8	8		0,170
M 37 05 380	A	380	230	15	5	6	6		0,180
M 37 10 380	A	380	230	18	10	8	8		0,200
M 37 15 430	A	430	260	18	15	8	8		
M 37 25 430	A	430	260	18	25	8	8		
M 37 35 430	A	430	260	18	35	8	8		
M 37 45 430	A	430	260	18	45	8	8		
M 36 14 500	A	500	290	18	14	8	8		
M 36 20 501	A	500	290	18	20	8	8		
M 36 30 500	A	500	290	18	30	8	8		
M 36 40 500	A	500	290	18	40	8	8		
M 36 50 500	A	500	290	18	50	8	8		
M 36 38 350	A	550	320	18	35	8	8		0,170
M 36 20 500	A	550	320	18	38	8	8		0,240
M 36 38 500	A	550	320	18	64	8	8		0,290
M 37 20 600	A	600	350	18	20	8	8		0,320
M 37 30 600	A	600	350	18	30	8	8		0,320
M 37 35 600	A	600	350	18	35	8	8		0,320
M 36 20 600	A	600	350	18	40	8	8		0,320
M 36 50 600	A	600	350	18	50	8	8		
M 36 36 600	A	600	350	18	60	8	8		0,320
M 36 25 701	A	700	400	22	25	10	8		
M 36 35 700	A	700	400	22	35	10	8		
M 36 25 700	A	700	400	22	44	10	8		0,370
M 36 55 700	A	700	400	22	55	10	8		
M 36 45 900	A	900	520	22	45	10	8		1,200
M 36 60 900	A	900	520	22	60	10	8		



Molle a gas telescopiche in acciaio inox Aisi 316 con attacchi a «sfera»

Stelo e tubo in acciaio inox, con possibilità di sostituire la testina terminale.

Telescopic gas springs manufactured in Aisi 316 stainless steel with sphere fastening

Stainless steel shaft and tube.

Articolo - Item	Mod.	←→ aperta-open mm.	←→ chiusa-closed mm.	Ø Cilindro-Cylinder	Stelo-Rod Ø	Filetto Threading	↑↓ Kg.	€/pc.	kg.
M 37 10 381	B	380	230	15	6	M5	10		0,180
M 37 35 381	B	380	230	15	6	M5	35		0,180
M 37 25 601	B	600	350	18	8	M8	25		0,390
M 37 50 601	B	600	350	18	8	M8	50		0,390



Supporti per molle a gas

Gas springs mounting plates

Articolo - Item	↑ mm.	Materiale - Material	€/pc.	kg.	
M 35 32 000	43 x 28	Nylon		0,060	
M 35 32 001	41 x 21	Nylon		0,060	
M 35 32 002	48 x 32	Aisi 316		0,060	
M 35 32 003	45 x 35	Aisi 316		0,060	
M 35 32 004	48 x 32	Aisi 316		0,060	
M 35 32 005	48 x 32	Aisi 316		0,060	
M 35 32 006	45 x 35	Aisi 316		0,060	
M 35 32 007	48 x 32	Aisi 316		0,060	
M 35 32 009	∅ 6	Acciaio		0,060	
M 35 32 010	∅ 6	Aisi 316		0,060	
M 35 32 012	48 x 32	Aisi 316		0,060	
M 35 32 013	35 x 25	Aisi 316		0,060	



Doccette - Showers



A

▶ N0125110



B

▶ N0100368



C

▶ N0125038



D

▶ N0105462



E

▶ N0101462



F

▶ N0110462



G

▶ N0133462



LED Shower

H

▶ N0160001



Doccette con rubinetto

Corpo realizzato in materiale anti-urto e valvole in ottone.
Colore bianco.

Showers with tap

Antichoc material and brass valves.
White colour.



Articolo - Item	Tipo - Type	Modello - Model	Raccordo - Connection	kg.	€/pc.
N 01 25 110	A	1/2" M	Standard		
N 01 00 368	B	1/2" M	Extra		
N 01 25 038	C	1/2" M	Standard		
N 01 05 462	D	1/2" M	Extra-Lux		
N 01 01 462	E	1/2" M	Lux con connettore - with coupling N0132060		
N 01 10 462	F	1/2" M	Lux colore crema - cream colour		
N 01 33 462	G	5/8" F	Lux colore crema - cream colour con connettore - with coupling N0133060		
N 01 60 001	H	1/2" M	Doccetta a led tonda - Round Led shower		



Contenitore con sportello doccia e tubo flessibile retinato 2,5 mt.

In versione con o senza miscelatore.
Completo di doccia e tubo.
Contenitore art. L5318011.
Fabbricato in Abs antiurto.

Case with cover, shower and flexible hose 2,5 mt.

With and without mixer.
Complete with shower and hose.
Case art. L5318011.
Manufactured in shockproof Abs.

Articolo - Item	Mod.	Tube-Hose	Doccia Shower	Miscelatore Mixer	Supporto Support	€/pc.	kg.
N 01 04 250	A	N0100250	N0125038	-	N0125001		
N 01 05 250	B	N0100258	N0125038	N0102411	N0125001		



Completo doccia + tubo serie «Economy»

Shower + hose series «Economy»

Articolo - Item	Doccia Shower	Tube-Hose mt.	Supporto Holder	Mod.	€/pc.	kg.
N 01 38 257	N0125038	2,50 - N0100258	-	A		
N 01 32 250	N0125038	2,50 - N0100250	N0134001	B		



Contenitore completo di kit per innesto rapido tubo doccia

Completo formato dal kit innesto rapido e dal contenitore in ABS.

Case with quick coupling fitting 3/8" M

Case manufactured in Abs.

Articolo - Item	Mod.	Tube Hose	Doccia Shower	Contenitore Case	Innesto Fitting	€/pc.	kg.
N 01 70 412	A	-	-	N0170004	N0101000		
N 01 03 412	B	N0100258	N0110462	N0170004	N0101000		

Tubi acqua - Hoses for water



Tubo acqua retinato

Retinato in nylon. Fabbricato in Pvc.

Hoses for water with wire

Steel wire and nylon. Manufactured in Pvc.

Articolo - Item	Ø mm	mt.	€/mt.	€/kg.	kg.
N 18 10 116	10 x 16	100			
N 18 12 118	12 x 18	100			
N 18 15 521	15 x 21	100			
N 18 19 526	19 x 26	50			
N 18 25 533	25 x 33	50			



Tubo acqua spiralato

Spirale in acciaio. Fabbricato in Pvc. Temp. -10°/+60°.

Hoses for water with wire

Steel wire. Manufactured in Pvc. Temp. -10°/+60°.

Articolo - Item	Ø mm	mt.	€/mt.	€/kg.	kg.
N 18 12 318	12 x 18	30			
N 18 16 622	16 x 22	30			
N 18 18 325	18 x 25	30			
N 18 20 627	20 x 27	30			
N 18 25 634	25 x 34	30			
N 18 30 640	30 x 40	30			
N 18 35 646	35 x 46	30			
N 18 38 648	38 x 48	30			
N 18 40 353	40 x 53	30			
N 18 45 355	45 x 55	30			
N 18 50 360	50 x 60	30			
N 18 60 375	60 x 75	30			
N 18 70 386	70 x 86	30			
N 18 80 297	80 x 97	20			

Tubi doccia - Flexible hoses for shower



Tubo flessibile per doccia con guarnizione mod. «Retinato» con attacchi 1/2" femmina - 1/2" femmina
Flexible hose for shower with embedded wire Female 1/2" Female 1/2"

Articolo - Item	← mt.	pz.	€/pc.	kg.
N 01 00 250	2,5	10		
N 01 00 400	4,0	10		
N 01 00 600	6,0	20		0,660



Tubo flessibile retinato completo di O-ring esterno con attacchi 3/8" - 1/2" femmina
Flexible hose with embedded wire with outer O-ring Female 3/8" - 1/2"
 Per il supporto in ottone cromato art. N0134060. Suitable for chromed brass support art. N0134060.

Articolo - Item	← mt.	pz.	€/pc.	kg.
N 01 00 258	2,5	10		
N 01 00 408	4,0	10		0,450



Tubo flessibile retinato e in tessuto
 Per il supporto in ottone cromato art. N0134060.
Flexible hose with embedded wire and in fabric
 Suitable for chromed brass support art. N0134060.

Articolo - Item	Attacco maschio Attacco femmina		← mt.	pz.	€/pc.	kg.
	Mod. Male fitting	Female fitting				
N 01 12 250 A	3/8"	1/2"	2,5	10		0,300
N 01 14 250 B	15/1 M	1/2"	2,5	10		0,300



Tubo flessibile per doccia con guarnizione mod. «Flessibile ottone» con attacchi 1/2" femmina - 1/2" femmina
Flexible hose for shower with embedded wire, gasket and connections Female 1/2" Female 1/2"

Articolo - Item	← mt.	pz.	€/pc.	kg.
N 01 25 034	2,5	10		0,300



Tubo flessibile ideale per miscelatori N0114201, N0120201, N0102251
Flexible hose ideal for mixers N0114201, N0120201, N0102251

Articolo - Item	Attacco maschio Attacco femmina		← mt.	pz.	€/pc.	kg.
	Male fitting	Female fitting				
N 01 12 152	15/1 M	1/2"	1,5	10		
N 01 12 252	15/1 M	1/2"	2,5	10		



Tubo piatto per acqua
 Lunghezza 15 mt.
 Confezione in scatola singola e cartone da 6.

Flat hose for water
 Length 15 mt.
 Single packing in box and carton of 6.

Articolo - Article	Lunghezza - Length mt.	€/pc.
N 01 15 305	15	



M 3/8"

M 3/8"



Kit innesto rapido per tubo doccia

Fabbricato in materiale plastico. Ideale per contenitore N0170004.

Quick-coupling spare parts

Manufactured in plastic material. Suitable to be fitted in the case art. N0170004.



Adattatore di collegamento per rubinetti tondi con diametro 15-25mm
Senza filetto.

Connection adapter for round taps with 15-25mm diameter
Without thread.



Mixer

Realizzati in ottone cromato.

Mixer

Made of chromed brass.

Articolo - Item	Scasso Recess Ø mm.	€/pc.	kg.
N 01 02 411	32		0,460

Articolo - Item	kit	€/Kit	kg.
N 01 01 000	10		0,020

Articolo - Item	€/pc.	kg.
N 01 65 406		



Supporti porta doccia

In plastica antiurto.

Shower support

In shockproof plastic.

Articolo - Item	Mod.	pcs.	€/pc.	kg.
N 01 34 001	Ottone-Brass/Abs	10		



Riduzione da 1/2" a 3/8"

Consente di collegare il miscelatore alla doccia.

Reduction 1/2" to 3/8"

To connect the mixer to the shower.

Articolo - Item	€/pc.	kg.
N 01 12 241		



Supporto curvo doppio femmina per docce

Realizzato in ottone cromato. Filettatura 1/2" femmina e 1/4" femmina.

Shower support

Made in chromed brass. Threading 1/2" female 3/8" female.

Articolo - Item	pcs.	€/pc.	kg.
N 01 33 060	10		



Supporto curvo femmina e maschio per docce

Realizzato in ottone cromato. Filettatura 1/2" femmina e 1/2" maschio.

Curved support female and male for showers

Made in chromed brass. Threading 1/2" female 1/2" male.

Articolo - Item	pcs.	€/pc.	kg.
N 01 32 060	10		



Contenitore per acqua pieghevole con rubinetto

Fabbricata in polietilene per alimenti.

Folding water tank with tap

Made of alimentary polyethylene.

Articolo - Item	Capacità - Capacity lt.	€/pc.	kg.
N 01 20 002	20		0,260



Doccia solare in speciale Pvc per ottenere l'acqua calda

Completa di tubo e doccia.

Solar sunshower in special Pvc to get hot water

With shower and tube.

Articolo - Item	Capacità Capacity lt.	€/pc.	kg.
N 01 20 300	20		0,330



Pompe a immersione

Funzionamento a 12V.
Modello da 10 L / min.
Confezione singola in scatola.

Immersion bilge pump

Power supply voltage 12V.
Max. flow rate 10 L / min.
Single packing in box.

Articolo - Article	Capacità - Capacity L / h.	€/pc.
P 02 12 010	600	



Pompe a immersione

Funzionamento a 12V.
Modello da 15 L / min.
Confezione singola in scatola.

Immersion bilge pump

Power supply voltage 12V.
Max. flow rate 15 L / min.
Single packing in box.

Articolo - Article	Capacità - Capacity L / h.	€/pc.
P 02 12 015	900	



Pompa elettrica ad immersione indicata per taniche e serbatoi acqua mod. «Caravel»

Fornita completa di cavo elettrico.
Funzionamento a 12V.
Prevalenza 3 mt.
Confezione singola in scatola.

Immersion bilge pump for water tanks mod. «Caravel»

3 mt. height.
Manufactured in strong plastic.
Low amperage draw 2,5A.
Connection 12V.
Single packing in box.

Articolo - Article	Capacità - Capacity L / h.	Pompe - Pumps Ø mm.	H. mm.	€/pc.
P 02 08 035	400	40	105	



Pompa elettrica ad immersione indicata per taniche e serbatoi acqua mod. «Concorde»

Fornita completa di cavo elettrico.
Funzionamento a 12V.
Prevalenza 4 mt.
Confezione singola in scatola.

Immersion bilge pump for water tanks mod. «Concorde»

4 mt. height.
Manufactured in strong plastic.
Low amperage draw 2,5A.
Connection 12V.
Single packing in box.

Articolo - Article	Capacità - Capacity L / h.	Pompe - Pumps Ø mm.	H. mm.	€/pc.
P 02 12 052	600	54	105	

Valvola a sfera a «T»

180° leva lunga.
Confezione singola.

«T» shape ball valve

180° long lever.
Single packing.

Articolo - Article	Modello - Model	Disegno - Drawing	€/pc.
N 01 18 138	F 3/8"	A	

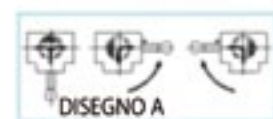

Autoclavi - Self-priming autoclave

Note:

Si consiglia l'uso delle pompe in locali bene areati.
To use the pumps in well aerated areas.

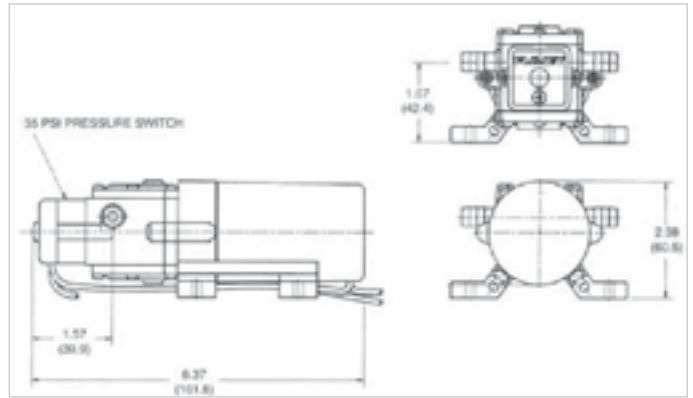

Autoclave autoaspirante

Bilge pump

Articolo - Item	LPM	Volts	Valvole - Valves	PSI	Uscite - Ports	kg.	€/pc.
P 16 12 220	3,8	12	EPDM	35 (2,4)BAR	3/8"		

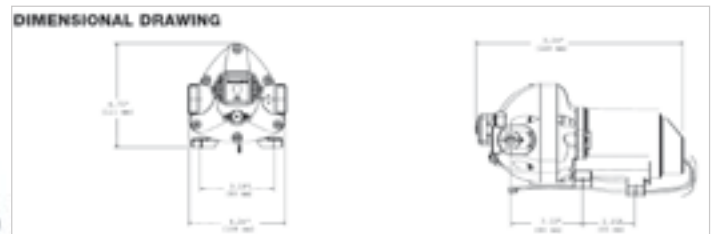

Autoclave autoaspirante

Bilge pump

Articolo - Item	GPM-LPM	Volts	AMP emessi - issued	interruttore di pressione PSI (Bar)	kg.	€/pc.
P 16 44 050	2,9 (11,0)	12	4,4	25 (1,6)		
P 16 24 344	2,9 (11,0)	24	2,2	25 (1,6)		*
P 16 20 916	2,0 (8,0)	12	3,5	25 (1,6)		

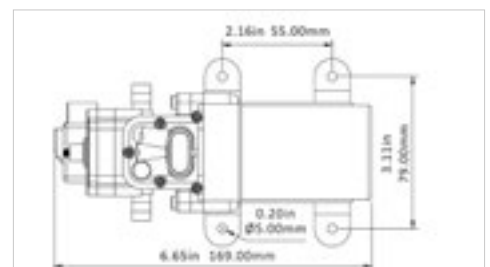
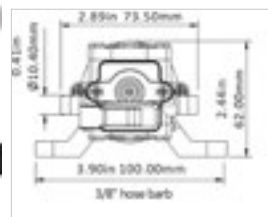

Autoclave autoaspirante 3,80 LPM -1,0 GPM

Bilge pump 3,80 LPM -1,0 GPM

Uscita ø 19 mm.

Articolo - Item	GPM/LPM	Volts	Amp.	Valvole - Valves	PSI	Uscite - Ports	kg.	€/pc.
P 16 38 022	1,00-3,80	12	4,0	EPDM	40	3/8"	0,620	



Pressostato

Pressure switch

Articolo - Item	PSI	Amp/h	kg.	€/pc.
P 16 20 035	35	20	0,100	*
P 16 20 040	40	20	0,100	*
P 16 20 045	45	20	0,100	*

* Disponibile su richiesta - Available on request

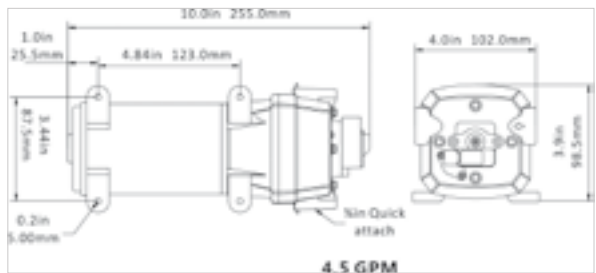
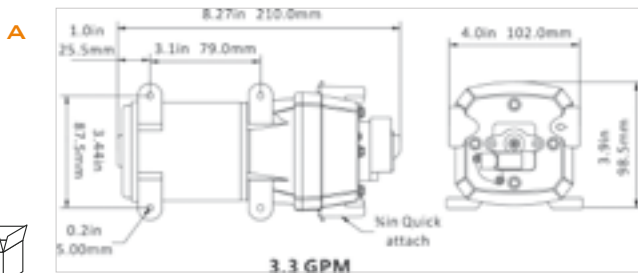

Autoclave autoadescente

Uscita ø 19 mm.

Self-priming bilge pump

Port ø 19 mm.

Articolo - Item	Mod.	GPM/LPM	Volts	Amp.	Valvole - Valves	PSI/BAR	Uscite - Ports	€/pc.	kg.
P 16 12 030	A	2,7 / 10	12	4,5	EPDM	17 / 1,2	Quick attach		1,800
P 16 12 040	B	4,5 / 17	12	15,0	EPDM	40 / 2,8	Quick attach		2,300
P 16 24 044	B	4,5 / 17	24	6,0	EPDM	40 / 2,8	Quick attach	*	2,300

ACQUA - WATER

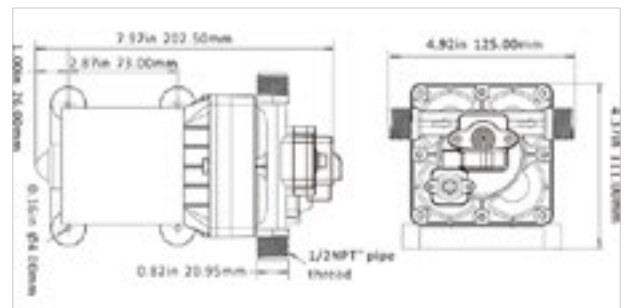

Autoclave autoadescente 11,3 LPM - 3,0 GPM

Diaphragm pump 11,3 LPM - 3,0 GPM

Articolo - Item	GPM/LPM	Volts	Max Draw (A)	Valvole - Valves	PSI/BAR	Switch	Diaphragm	Wire connections	Uscite - Ports	€/pc.	kg.
P 16 12 011	3,0 / 11,3	12	7,5	EPDM	55 / 3,8	Demand	Santoprene	2-Pin/Leads	1/2"-14 MNPT		

* Disponibile su richiesta - Available on request



made by TREM

- ▶ Tubi di raccordo maschio su entrambi i lati
- ▶ Male connection hoses on both sides

Miscelatore con doccetta bianca a levetta e tubo 1,50 mt.

Shower faucet with flexible hose 1,50mt. and mixer

Articolo - Item	kg.	€/pc.
N 01 04 311		



made by TREM

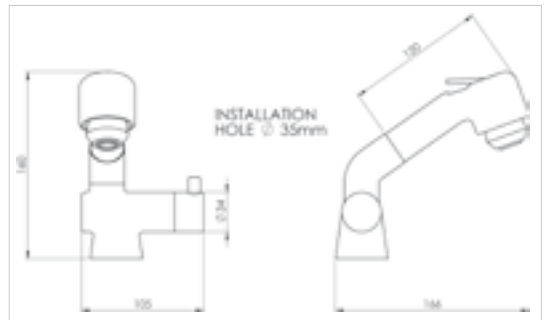

Miscelatore monocomando con doccetta bianca a levetta e tubo

Shower faucet with flexible hose and mixer

Articolo - Item	mm.	mt.	kg.	€/pc.
N 01 15 150	131Lx152H	1,50		

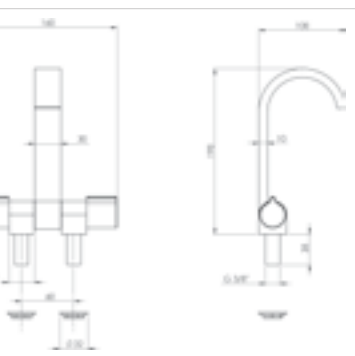

A

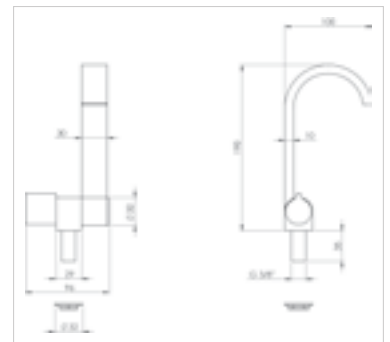

B



made by TREM

Miscelatore e rubinetto a canna piatta abbattibile

Attacco 3/8" maschio. Altezza attacco 3 cm.

Mixer and tap with flat folding spout

Male 3/8" connection. Connection height 3cm.

Articolo - Item	Modello	mm.	kg.	€/pc.
N 01 19 160	A - Miscelatore-Mixer	190 x 160		
N 01 19 098	B - Rubinetto-Tap	190 x 98		



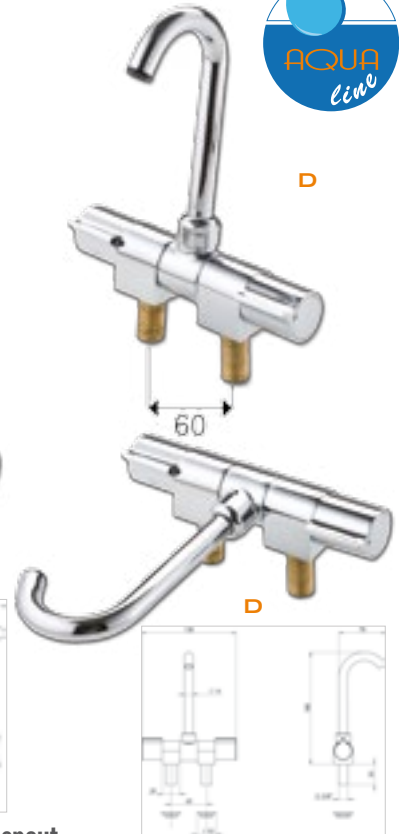
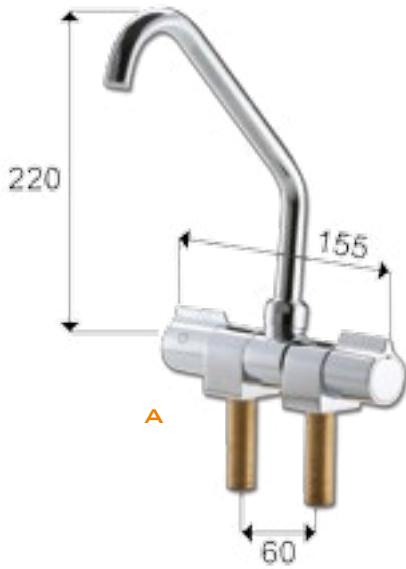

Miscelatore e rubinetto abbattibile

Canna abbattibile.
Attacco 3/8" maschio. Altezza attacco 3 cm.

Mixer and tap with folding spout

Folding spout.
Male 3/8" connection. Connection height 3 cm.

Articolo - Item	Modello	kg.	€/pc.
N 01 00 311	A - Miscelatore-Mixer Ø 14 mm. h 200 mm.		
N 01 00 315	B - Rubinetto-Tap Ø 14 mm. h 200 mm.		
N 01 15 130	C - Rubinetto corto - Short tap Ø 14 mm. h 160 mm.		
N 01 03 110	D - Miscelatore corto - Short mixer Ø 14 mm. h 160 mm.		



Confezione sfusa CANTIERI - Bulk pkg. for SHIPYARD

Articolo - Item	Modello	€/pc.	kg.
N 01 15 130 C	C - Rubinetto corto - Short tap Ø 14 mm. h 160 mm.		
N 01 03 110 C	D - Miscelatore corto - Short mixer Ø 14 mm. h 160 mm.		



Miscelatore monocomando abbattibile

Canna abbattibile.
Attacco 3/8" maschio.

Mixer with folding spout

Folding spout.
Male 3/8" connection.

**GLI UNICI MODELLI H.39mm A RIPOSO!
THE SOLE MODELS 39mm HIGH CLOSED!**

Articolo - Item	Modello	mm.	kg.	€/pc.
N 01 14 038	A - Miscelatore-Mixer Ø 14 mm.	H 200 x 105		
N 01 18 038	B - Miscelatore corto a canna maggiorata-Short mixer Ø 14 mm.	H 160 x 105		
N 01 00 195	C - Miscelatore a canna piatta-Mixer with flat spout 195/45x110x105	H 195 x 110		



made by TREM



Miscelatore monocomando
Per lavello canna girevole.
Attacco 1/2" femmina.

Single control mixer
Swivelling mixer for sink.
Female connection 1/2".

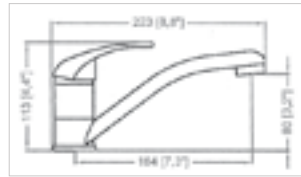

Articolo - Item	mm.	kg.	€/pc.
N 01 14 201	140	0,860	
N 01 20 201	200	1,000	



made by TREM



Monocomando miscelatore cromato + doccia estraibile cromata
Tubo flessibile in ottone cromato da 1,5 mt.

Shower faucet with flexible and mixer
Flexible hose in chromed brass 1,5 mt long.

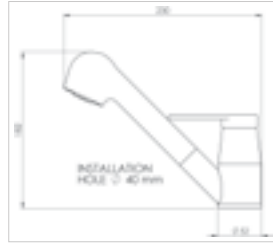

Articolo - Item	Monocomando Lever Ø mm.	tot mm.	Doccia Shower mm.	Sporgenza Protrusion mm.	kg.	€/pc.
N 01 02 251	40	110	160	175	1,700	



made by TREM



Miscelatore ceramico girevole per lavello cucina
Rubinetto in ottone cromato.

Rotating mixer tap
Made in chromed brass.

Articolo - Item	Altezza mm.	Sporgenza mm.	Collo Ø mm.	€/pc.	kg.
N 01 35 163	350	162,50	55		



Rubinetti e mixer

Taps and mixers

Articolo - Item	Modello	kg.	€/pc.
N 01 00 210	E - Miscelatore - Mixer		
N 01 01 212	F - Rubinetto sinistra - Left tap		
N 01 02 212	G - Rubinetto destra - Right tap		



Beccucci snodati per rubinetti Water saver

Articolo - Item	Mod. attacco-fitting	kg.	€/pc.
N 01 15 205	Maschio-Male 15/1"	0,050	
N 01 12 105	Femmina-Female 1/2"	0,050	

Lavelli - Sinks



Lavelli semisferici in acciaio inox Round sinks in stainless steel

Lucidati a specchio.

Mirror polished. With drain cover.

Articolo - Item	Ø mm.	Spessore-Thickness		€/pc.	kg.
		int. mm.	ext. mm.		
Z 08 32 026	int. 260 - ext. 295	0,6		*	0,420
Z 08 32 030	int. 300 - ext. 335	0,8		*	0,900



Lavello ovale in acciaio inox Oval sink in stainless steel

Spessore 0,8 lucidati a specchio.

Mirror polished oval shape sink. With drain cover.

Articolo - Item	int. mm.		mm.	€/pc.	kg.
	↔	↔			
Z 08 24 375	240 x 375	265 x 390	125	*	



Lavelli tondi in acciaio inox Round sinks in stainless steel

Spessore 0,8 lucidati a specchio.

Mirror polished round shape sink. With drain cover.

Articolo - Item	int. mm.		mm.	€/pc.	kg.
	↔	↔			
Z 08 29 000	260	290	180		
Z 08 30 000	300	325	180		



Lavelli rettangolari in acciaio inox Rectangular sinks in stainless steel

Spessore 0,8 lucidati a specchio.

Mirror polished round shape sink. With drain cover.

Articolo - Item	Mod.	int. mm.		mm.	€/pc.	kg.
		↔	↔			
Z 08 15 300	A	150 x 300	170 x 320	150		
Z 08 30 238	B	238 x 300	260 x 325	150		
Z 08 30 330	B	330 x 330	350 x 350	150		



► I lavelli vengono sempre venduti privi di piletta - The sinks are always supplied without waste kit

Pilette per lavelli - Sink waste kit

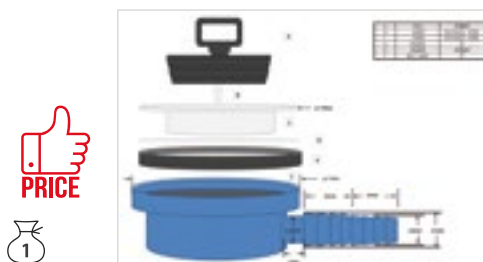

Piletta per lavelli

Per lavelli con uscite sia da 20mm che da 25mm, grazie al portagomma raccordato.

Sink waste kit



For sinks with 20mm and 25mm outlets, thanks to the hose connector.

Articolo - Item	Mod.	kg.	€/pc.
Z 08 20 090	90°		





* Disponibile su richiesta - Available on request

Fascette stringitubo in acciaio inox
Clamps in stainless steel

Articolo - Item	Ø mm. min.	Ø mm. max.	 pcs.	 kg.	€/pc.	€/box.
E 60 00 020	12	22	10	0,120		
E 60 00 032	16	24	10	0,130		
E 60 00 051	30	45	10	0,170		
E 60 00 070	32	50	10	0,180		
E 60 00 089	40	60	10	0,200		
E 60 00 108	50	70	10	0,210		
E 60 00 127	60	80	10	0,220		
E 60 00 140	70	90	10	0,230		
E 60 00 156	90	110	10	0,250		
E 60 00 184	100	120	10	0,260		
E 60 00 227	110	130	10	0,330		



Fascette stringitubo «Mini» in acciaio inox
Clamp in stainless steel Aisi 304 «Mini»

Articolo - Item	Ø mm. min.	Ø mm. max.	 pcs.	 kg.	€/pc.	€/box.
E 60 06 007	7	9	10	0,400		
E 60 06 009	9	11	10	0,500		
E 60 06 011	11	13	10	0,600		

Serbatoio di espansione
Tank for fresh water

Ideale per acqua potabile, per pompe autoclavi e sistemi pressurizzati. Fabbricato in plastica, capacità 1 lt.

Suitable for fresh water. Manufactured in plastic. Capacity 1 lt.

Articolo - Item	← mm.	 kg.	€/pc.
N 01 01 024	240	0,360	

Filtri per docce e pompe di sentina Filter for shower or bilge pumps

Da montare sulla tubazione.

Pipe installation.

Articolo - Item	Portagomma - Joint	 kg.	€/pc.
N 01 18 521	¾" Ø 19,5 mm.	0,080	
N 01 18 523	½" Ø 12,7 mm.	0,080	

Scaldabagni - Boiler

Boiler ATI

Fabbricato con caldaia in acciaio inox Aisi 316 rivestimento esterno inox Aisi 316 lucidato a specchio e scambiatore di calore inox. Funzionamento con scambiatore di calore o resistenza elettrica di 1200W a 230V. Isolamento spinto tra serbatoio e carcassa in poliuretano espanso.

Boiler ATI

Manufactured with Aisi316 stainless steel boiler, external coating in mirror polished Aisi316 stainless steel and stainless steel heat exchanger. Operation with heat exchanger or electric resistance of 1200W to 230V. supercharged insulation between tank and frame in foam polyurethane.

Articolo - Article	mod.	Lt.	Lunghezza tot. mm.	interasse staffe mm.	 kg.	€/pc.
N 01 12 120	A	12	387	175		*
N 01 22 120	B	22	485	335		
N 01 30 120	B	30	619	470		
N 01 45 120	B	45	878	730		*
N 01 20 120	C	20.	485	457		*

* Disponibile su richiesta - Available on request

Serbatoi - Tanks



Serbatoi rigidi colore bianco per riserva acqua

Con tappo di ispezione e fori ciechi già filettati per raccordi.
In materiale atossico.
6 predisposizioni per raccordi: 2 ø38, 3 ø15, 1 ø19 mm.

Rigid water tanks for water

Manufactured in non-toxic material.

Articolo - Item	Lt.	cm. A x B	cm.	kg.	€/pc.
N 01 20 077	77	80 x 48	20		*
N 01 20 084	84	88 x 48	20		*
N 01 20 092	92	80 x 58	20		*
N 01 20 108	108	80 x 68	20		*
N 01 22 077	64	77 x 38	22		*
N 01 22 088	73	88 x 38	22		*
N 01 22 110	92	112 x 38	22		*
N 01 22 123	103	123 x 38	22		*
N 01 22 133	110	133 x 38	22		*
N 01 05 026	48	48 x 40	26		*
N 01 10 026	105	88 x 48	26		*
N 01 08 030	80	65 x 45	28		*
N 01 28 094	94	75 x 45	28		*
N 01 28 105	105	90 x 45	28		*
N 01 28 120	120	95 x 45	28		*
N 01 28 132	132	105 x 45	28		*
N 01 28 150	150	120 x 45	28		*
N 01 35 148	148	88 x 48	35		*

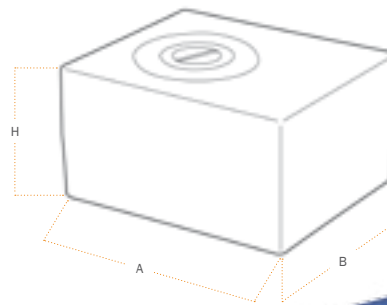
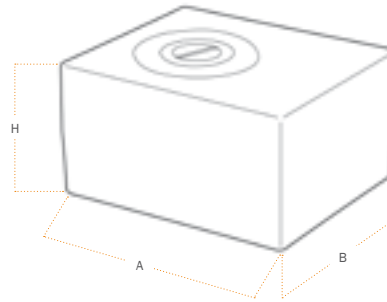

Serbatoi acque nere

Serbatoi in polietilene rigido per acque nere. Sono completi di 8 fori sulle due testate, da 3/4" - 1" 1/2 per carico, scarico e sfiato. Certificati in accordo con norme ISO 8099.

Waste tanks

Made in polyethylene.
With 8 unions 3/4"-1" 1/2 to fill and drain.
ISO 8099 Specification.

Articolo - Item	Lt.	mm.	mm.	€/pc.	kg.
N 01 80 047	47	480 x 400	260 rettang.		
N 01 80 077	77	480 x 800	200		
N 01 80 092	92	580 x 800	200		



Tappi per serbatoi rigidi

Fabbricati in plastica.

Plugs for water tank

Manufactured in plastic.

Articolo - Item	Mod.	Ø mm.	kg.	€/pc.
N 01 31 130	Tappo maschio-Male	130		



Raccordi per serbatoi rigidi

Fabbricati in nylon.

Connections for water tanks

Manufactured in nylon.

Articolo - Item	Mod.	mm.	"	Tipo Type	kg.	€/pc.
N 01 35 014	A	35	1"1/4	Carico-Inlet		
N 01 12 012	B	12	1/2"	Scarico-Outlet		
N 01 12 038	C	12	3/8"	Sfiato-Air hole		
N 01 35 038	D	32	1"1/4	Carico-Inlet		
N 01 12 090	E	12	1/2"	Sfiato-Air hole		



* Disponibile su richiesta - Available on request



Tanica su ruote per acqua fresca **Wheel tank for fresh water 35lt. da 35lt.**

Articolo - Item	↑ mm.	kg.	€/pc.
N 01 61 146	800x360x170		



Tanica su ruote 24lt. **Wheel tank 24lt.**

Articolo - Item	↑ mm.	kg.	€/pc.
N 01 60 066	500x330x250		



Tanica per acque di scarico 19lt. **Waste water tank 19lt.**

Articolo - Item	↑ mm.	€/pc.
N 01 60 062	480x280x170	



Connettore NEOWATER

Per tutti i bocchettoni d'immissione per serbatoi. Attraverso i 2 adattatori in aggiunta il connettore può essere utilizzato per svariati bocchettoni d'immissione. Uno per coperchio Ø 77MM e l'altro per coperchio Ø 67MM. Anche per piccoli bocchettoni d'immissione, DETHLEFFS o LMC. Adatto per taniche con o senza sfiato.

NEOWATER connector

For all the pipe fillers for tanks. Through 2 additional adapters, the connector can be used for different pipe fillers. One for cap Ø 77MM and the other for cap Ø 67MM. Also for little pipe fillers, DETHLEFFS or LMC. Proper for tanks with or without filling.

Articolo - Item	kg.	€/pc.
N 01 65 124		



Connettore NEOWATER

Per bocchettoni d'immissione con diametro di piccole dimensioni, spesso sotto una copertura con 2 ganci interni di ampia portata. Ad esempio va bene per HYMER 2003-2006. Attraverso una camera d'aria speciale per taniche con o senza sfiato.

NEOWATER connector

For pipe fillers with little diameters, often under a cover with 2 wide-range internal hooks. For example is ok for HYMER 2003-2006. Through a special inner tube for tanks with or without filling.

Articolo - Item	kg.	€/pc.
N 01 65 121		



Corpo bocchettone in nylon per riempimento serbatoi acqua e carburante

Foro di uscita Ø 35 mm.
Confezione singola.

Nylon vent for replenishment of water and fuel tanks

Outlet hole Ø 35 mm.
Single packing.

Articolo - Article	Colore - Colour	€/pc.
P 21 35 074	Bianco - White	
P 21 35 080	Nero - Black	

Tappo a 3 razze per bocchettone acqua e carburante

Foro di uscita Ø 35 mm.
Confezione singola.

Cap for water and fuel vent

Outlet hole Ø 35 mm.
Single packing.

Articolo - Article	Colore - Colour	€/pc.
N 28 74 210	Bianco - White	
N 28 80 210	Nero - Black	

Tappo a 2 razze per bocchettone acqua e carburante

Confezione singola.

Cap for water and fuel vent

Single packing.

Articolo - Article	Colore - Colour	€/pc.
N 28 74 169	Bianco - White	
N 28 80 168	Nero - Black	



Presca esterna con tappo bocchettone

Confezione singola.

Water inlet with lock and new model cover flap

Single packing.

Articolo - Article	Colore - Colour	€/pc.
N 01 06 001	Bianco - White	

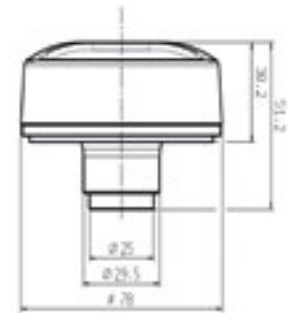

Valvole a chiusura ermetica 3" accessori e raccordi

Confezione in sacchetto singolo.

3" hermetic-seal valves accessories and connections

Single packing in polybag.

Articolo - Article	Mod.	Descrizione - Description	€/pc.
N 01 11 976	A	Adattatore femmina da 3" per serbatoi 3" female adaptor for tanks	
N 01 11 975	B	Raccordo dritto attacco a baionetta 3" 3" Straight connection bayonet coupling	
N 01 11 984	C	Adattatore a pioli attacco a baionetta 3" 3" adaptor bayonet coupling	
N 01 21 007	D	Adattatore per valvola versione B completo di guarnizione Adaptor for valve type B with gasket	
N 01 11 969	E	Corpo valvola da 3" in Abs completo di guarnizione e 4 viti 3" Abs valve body complete with gasket and 4 screws	

Raccordi rapidi - Quick fittings for hydraulic systems

Raccordi rapidi Ø 12 mm.

Montaggio rapido a scatto con una semplice pressione del tubo.
Clips di sicurezza sul raccordo per l'innesto realizzati in plastica atossica in conformità alle normative vigenti (D.M. 21/03 1973 e successive modifiche).
Riutilizzabili.
Tubo in polietilene semirigido.

Quick fittings Ø 12 mm.

Quick fitting by a simple pressure of the pipe.
Safety clips on the connection manufactured in non-toxic plastic according to Rules (D.M. 21/03 1973).
Can be re-used.
Pipe manufactured in semirigid polyethylene.



Raccordo a gomito Elbow fitting 12 mm. 12 mm.

Articolo - Item	kg.	€/pc.	€/box
N 01 12 020			



Raccordo dritto Straight fitting 12 mm. 12 mm.

Articolo - Item	kg.	€/pc.	€/box
N 01 12 021			



Raccordo a T «T» Hose connector 12 mm. 12 mm.

Articolo - Item	kg.	€/pc.	€/box
N 01 12 005			



Raccordo a Y «Y» Hose connector 12 mm. 12 mm.

Articolo - Item	kg.	€/pc.	€/box
N 01 12 023			



Terminale 12 mm. Straight fitting 12 mm. Femmina 3/8" 3/8"

Articolo - Item	kg.	€/pc.	€/box
N 01 12 006			



Codolo 12 mm. Hose shank 12 mm. Maschio 1/2" 1/2" Male

Articolo - Item	kg.	€/pc.	€/box
N 01 12 004			



Codolo 12 mm. Hose shank 12 mm. Maschio 3/8" 3/8" Male

Articolo - Item	kg.	€/pc.	€/box
N 01 12 008			



Terminale 12 mm. Straight fitting 12 mm. Maschio 3/8" 3/8" Male 3/8"

Articolo - Item	kg.	€/pc.	€/box
N 01 12 386			



Gomito con codolo Elbow fitting 12 mm. 12 mm.

Articolo - Item	kg.	€/pc.	€/box
N 01 12 024			



Terminale 12mm Femmina 1/2" Straight fitting 12 mm. - 1/2" F

Articolo - Item	kg.	€/pc.	€/box
N 01 12 104			



Terminale 12 mm. Maschio 1/2" Straight fitting 12 mm. - 1/2" M

Articolo - Item	kg.	€/pc.	€/box
N 01 12 204			



Clip blocca pinza Clamp

Articolo - Item	kg.	€/box
N 01 38 000C		



Tagliatubi Pipe cutting device

Articolo - Item	kg.	€/pc.
N 01 38 012		

**Ideale per pompe
Ideal for pumps**



Raccordo a gomito Elbow fitting 12 mm. 12 mm. Fem. 1/2" 1/2" F

Articolo - Item	kg.	€/pc.	€/box
N 01 12 040			

**Con rubinetto
With tap**



Raccordo dritto Straight tap 12 mm. 12 mm.

Articolo - Item	Mod.	€/pc.	€/box
N 01 12 212	-		
N 01 12 213	Asta-Rod 230mm.		

Tubo rosso 12 mm. in Red pipe 12 mm. rotoli da 100 mt. reel of 100 mt.

Articolo - Item	mt.	kg.	€/mt.
N 01 82 116	100		

Tubo blu 12 mm. in Blue pipe 12 mm. rotoli da 100 mt. reel of 100 mt.

Articolo - Item	mt.	kg.	€/mt.
N 01 75 116	100		

I RACCORDI SONO PRIVI DI GUARNIZIONE N0138000C (DA ACQUISTARE A PARTE) - FITTINGS ARE SOLD WITHOUT CLAMP N0138000C (TO BUY SEPARATELY)



**Energia
Power**

Phon - Hair dryer

t-phon



made by **TREM**

Phon 12V.

Dotato di cavo 2 mt. e spina accendisigari.

Hair dryer 12V.

With cigarette lighter plug.
Cable length 200 cm.

Articolo - Item	Potenza-Power Watt	Mod.	Amp.	€/pc.	kg.
L 64 12 156	156	A	9		0,300
L 64 12 180	180	B	9		

Accessori elettrici vari - Electrical accessories



Saldatore 12V. con attacco accendisigari

Soldering iron with cigarette lighter plug

Articolo - Item	Volts	kg.	€/pc.
L 06 12 502	12	0,090	



Macchina caffè espresso

Presse accendisigari.
12V. 130W. 10A.

Coffee maker

With cigarette lighter plug.
12V. 130W. 10A.

Articolo - Item	kg.	€/pc.
L 64 02 490	0,480	



A

B

**Lampada da interni a led,**

Realizzata in alluminio cromato e lenti satiniate.

Tipo led: "4014" bianco caldo. Colore temperatura 3000K. IP65.

Led ceiling light

Manufactured in chromed plated aluminium and frosted lens. Led type: "4014" warm white led. Color Temperature 3000K. IP65.

Articolo - Item	Mod.	Volts	Light Bulb	Led Ø mm.	Lumen	Watt	Interr. Switch	€/pc.	kg.
L 44 00 252	A	10-30VDC	27	70	343	5	NO		
L 44 00 253	B	10-30VDC	42	105	558	8	Touch Switch		

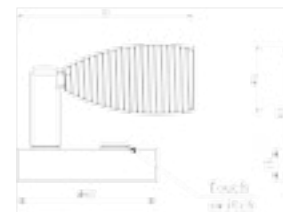
**Luce da lettura a led 10-30V DC**

Realizzata in alluminio cromato. Tipo led: 1 x 3W luce calda Temperatura colore: 2800-3200K Interruttore touch (dimmerabile)

Led reading light 10-30V DC

Manufactured in aluminium, pearl chromium. Led type: 1 x 3W warm white led Color temperature: 2800-3200K Touch switch (dimmable)

Articolo - Item	mm.	Volts	Lumen	€/pc.	kg.
L 44 12 022	82(L) x 65(W) x 63(H)	10-30V DC	200		

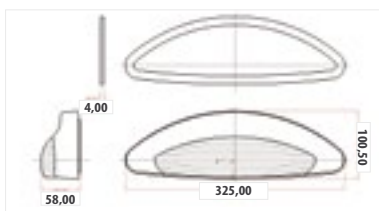

waterproof

**Luce «Star Lux»**

Fabbricata in plastica con vetro in policarbonato. Per utilizzo da interno o da esterno.

Light «Star Lux»

Made of plastic material with polycarbonate glass. Suitable for indoor and outdoor applications.

Articolo - Item	Modello Model	mm.	€/pc.	kg.
L 44 24 666	36 LED 7W	325 x 100 x 50H		0,530

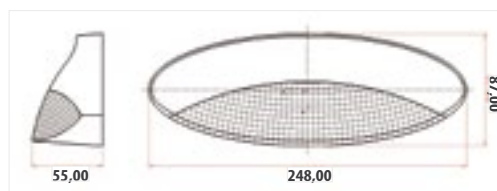
**Luce «Star Lux»**

Fabbricata in plastica con vetro in policarbonato. Per utilizzo da interno o da esterno.

Light «Star Lux»

Made of plastic material with polycarbonate glass. Suitable for indoor and outdoor applications.

Articolo - Item	Modello Model	mm.	€/pc.	kg.
L 44 10 285	1 x 10W. Halogen	250 x 87 x 56H		0,280

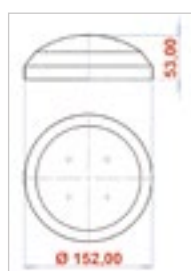
**Plafoniera tonda 12V.**

Provvista di lampadina alogena 12V. 10W. Tubo a 3W. Ø base 152 mm. Confezione singola in scatola.

Dome light 12V.

With halogen bulb 12V. 10W. Tube 3W. Base Ø 152 mm. Single packing in box.

Articolo - Article	Modello - Model	Ø Base mm.	€/pc.
L 44 74 951	Bianco - White	152	

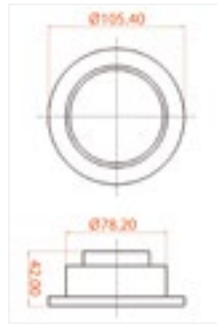

Plafoniera al led

Fabbricata in acciaio inox.

Led light

Manufactured in stainless steel.

Articolo - Item	Ø mm.	Ø esterno outer Ø mm.	Incavo Recess Ø mm.	€/pc.	kg.
L 44 00 553	80	106	78		0,150

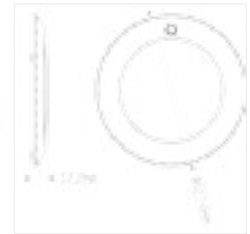

Plafoniera a led basso profilo con interruttore integrato doppia luce

Realizzata in plastica.
 Tipo: 30 led luce bianca + 26 led luce blu.
 Temperatura colore: 2900-3200K
 Montaggio a superficie.

Slim led ceiling light with integrated switch double light

Made in plastic.
 Led type: 30 x white led + 26 x blue led
 Color temperature: 2900-3200K
 Surface mount.

Articolo - Item	mm.	Volts	Lumen	Watts	€/pc.	kg.
L 44 10 608	Ø 127 x 12,2 (Thickness)	10-30V DC	390	6		

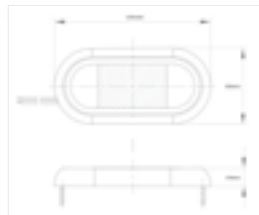

Lampada da interni a led

Realizzata in plastica bianca. Led color bianco naturale. Modello con interruttore a sensibilità tattile.

Led interior light

Manufactured in plastic, white colour. Nature white led. Model with touch switch (dimnable).

Articolo - Item	mm.	Volts	LED	Lumen	€/pc.	kg.
L 44 02 768	136x66x16	10-30VDC	12x1W	950LM		



Lampada da interni a led

Realizzata in plastica bianca. Led color bianco naturale. Modello con interruttore a sensibilità tattile.

Led interior light

Manufactured in plastic, white colour. Nature white led. Model with touch switch (dimnable).

Articolo - Item	mm.	Volts	LED	Lumen	€/pc.	kg.
L 44 02 769	186x66x16	10-30VDC	18x1W	1330LM		

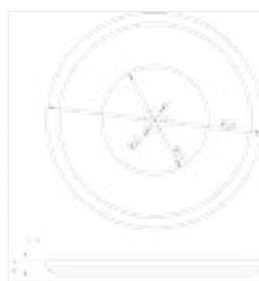

Plafoniera a led, 9-16V DC

Realizzata in PMMA, colore bianco.
 Tipo led: 42 x SMD x 0,2W luce calda. Temperatura colore 2800-3200K
 Interruttore touch (dimmerabile)

Led ceiling light, 9-16V DC

Made in PMMA, white colour.
 42 x SMD x 0,2W warm white led
 Color temperature: 2800-3200K
 Touch switch (dimnable)

Articolo - Item	mm.	Volts	Lumen	Watts	€/pc.	kg.
L 44 74 264	Ø 120 x 8,5 (H)	9-16V DC	500	6		

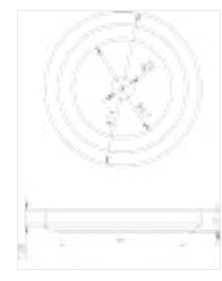

Plafoniera a led, 9-16V DC

Realizzata in PMMA, colore bianco.
 Tipo led: 30 x SMD x 0,2W luce calda. Temperatura colore 2800-3200K
 Interruttore touch (dimmerabile)

Led ceiling light, 9-16V DC

Made in PMMA, white colour.
 30 x SMD x 0,2W warm white led
 Color temperature: 2800-3200K
 Touch switch (dimnable)

Articolo - Item	mm.	Volts	Lumen	Watts	€/pc.	kg.
L 44 74 263	Ø 74 x 10 (H)	9-16V DC	300	3		

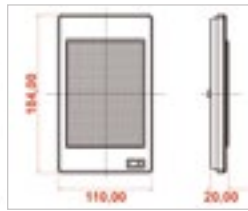

Plafoniera quadrata con interruttore

Realizzata in materiale plastico. Provvista di 48 led 12V. Interruttore 3 posizioni OFF - ON - accesa a metà. Confezione singola in scatola.

Square dome light with switch

Made of plastic material. Supplied with 48 leds 12V. Switch OFF - ON - half switched on. Single packing in box.

Articolo - Article	Colore - Colour	mm.	€/pc.
L 44 01 557	Bianco - White	184 x 110	



Interno-Indoor

Lampada da carteggio con led 12V.

Provviste di braccio flessibile.

Led chart light 12V.

With articulated bracket.

Articolo - Item	cm.	12V.	kg.	€/pc.
L 44 08 060	50	12V.	0,200	

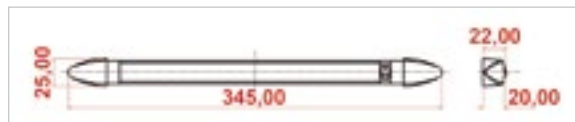

Plafoniera «Rocking»

Realizzata in alluminio, orientabile a 270°. Provvista di 20 led e di interruttore. Funzionamento a 12V. Basette 21 x 16 mm. Confezione singola in scatola.

Ceiling light «Rocking»

Made of aluminium. Adjustable 270°. Supplied with 20 leds and switch. 12V. operation. Supports 21 x 16 mm. Single packing in box.

Articolo - Article	Lunghezza - Length mm.	€/pc.
L 44 20 290	347	

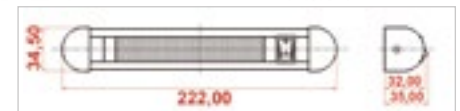

Plafoniera «Strip»

Realizzata in Abs. Applicabile in qualsiasi posizione. Funzionamento a 12V. Provvista di interruttore. Confezione singola in scatola.

Ceiling light «Strip»

Made of Abs. 12V. operation. Supplied with switch.

Articolo - Article	Colore - Colour	Lunghezza - Length mm.	Lampade - Lamps	€/pc.
L 44 09 280	Grigio-Grey	220	9 led	

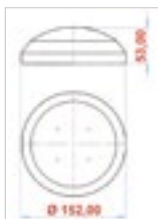

Interno-Indoor



Plafoniera tonda

Provvista di lampadina e tubo 1W.

Dome light

With bulb and tube 1W.

Articolo - Item	Modello Model	Vetro-Glass Ø mm.	Base Ø mm.	12V. - 3W.	kg.	€/pc.
L 44 74 951	□	100	152	12V. - 3W.	0,190	

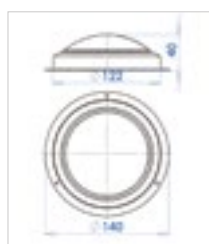

Interno-Indoor



Plafoniera rotonda

Fabbricata in acciaio smaltato, con lampadina alogena.

Round ceiling light

Manufactured in enamelled steel. With halogen bulb.

Articolo - Item	Vetro-Glass Ø mm.	Base Ø mm.	12V. - 10W.	kg.	€/pc.
L 44 00 550	95	140	12V. - 10W.	0,210	

Lampade - Lights

Faretto al Led

Accensione a pressione del vetro.
Provvisto di 16 led, Ø 100 mm.
Montaggio al piano.
Fabbricata in plastica antiurto.
Confezione singola in scatola.

Led light

ON by pressing the glass.
With 16 led. Ø 100 mm.
Mounting on plane.
Manufactured in shockproof plastic.
Single packing in box.

Articolo - Article	Colore - Colour	€/pc.
L 44 74 165	Bianco - White	

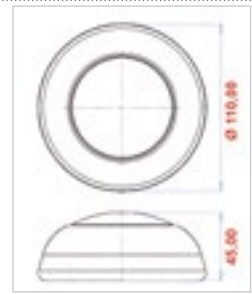

Faretto al Led

Accensione a pressione del vetro.
Provvisto di 16 led, Ø 100 mm.
Montaggio a incasso.
Fabbricata in plastica antiurto.
Confezione singola in scatola.

Led light

ON by pressing the glass.
With 16 led. Ø 100 mm.
Hollow mounting.
Manufactured in shockproof plastic.
Single packing in box.

Articolo - Article	Colore - Colour	€/pc.
L 44 74 166	Bianco - White	

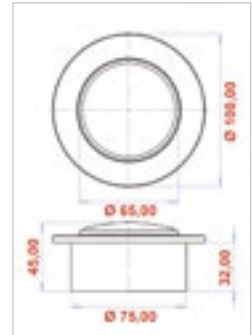

Faretto al Led

Fabbricato in acciaio inox.
Ø 80 mm.
Basso consumo.
Confezione singola in scatola.

Led light

Made in stainless steel.
Ø 80 mm.
Low consumption.
Single packing in box.

Articolo - Article	Modello - Modell	Ø Esterno Ext. mm.	Ø Incasso Flush mm.	€/pc.
L 44 00 553	Lucidato con vetro satinato - Polished with glass	106	78	

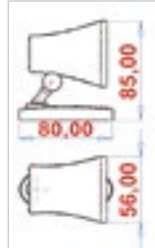
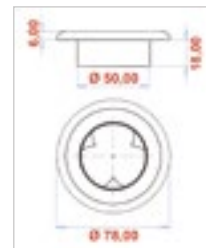

Applique da parete 12V.

Fabbricata in policarbonato metallizzato.
Lampadina alogena o Led.
Confezione singola in scatola.

Spotlight 12V.

Made of polycarbonate.
Supplied with halogen bulb or Led.
Single packing in box.

Articolo - Article	Base	Proiettore - Spotlight mm.	€/pc.
L 44 00 939	Ovale - Oval	Alogeno - Halogen 10W	
L 44 12 939	Ovale - Oval	Led	

Faretto al led da incasso 12V.

Provvisa di 3 led a luce bianca.
Basso consumo.
Confezione singola in scatola.

Led light 12V. flush mounted

With 3 led white light.
Low consumption.
Single packing in box.

Articolo - Article	mm.	Colore - Colour	€/pc.
L 44 00 158	Ø 76 x 48 interno - inner	Bianco - White	



►Interno-Indoor



Lampade alogene da parete

Fabbricate in nylon.

Reading light

Manufactured in nylon.

Articolo - Item	Tipo Type	Vetro Glass	Light Bulb	kg.	€/pc.
L 44 00 926	A	■	12V. - 10W.	0,170	
L 44 74 926	B	□	12V. - 10W.	0,160	

Appliche snodata
in ottone cromato

Provvisa di interruttore.

Articulated reading light
in chromed brass

With switch.

Articolo - Item	base mm.	Light Bulb	kg.	€/pc.
L 44 00 943	40 x 75	G4 - 12V. - 20W.	0,160	



►Interno-Indoor



Lampadine e bulbi alogeni - Halogen bulbs











Foto Picture	Articolo Item	Volt	Watt	Attacco Fitting	↑ → mm.	Tipo-Type	Montata di serie Standard fitted	Per fanale For light	Box	€/pc.	€/box	kg.
Lampadine a Siluro - Siluro blubs												
	L 08 08 012	12	7	Siluro	11x39,5	Alogena	Mini Star	-				
	L 08 10 012	12	10	Siluro	11x38,5	Alogena	Orsa Minore	-				
	L 08 08 024	24	10	Siluro	11x38	Alogena	-	Orsa Minore Mini Star				
	L 08 15 012	12	15	Siluro	15x44	Alogena	Stella Polare 12V. 112,5° - 125°	-				
	L 08 10 041	12	10	Siluro	11x44	Alogena	Stella Polare 12V. 135° Croce del Sud	-				
	L 08 15 024	24	15	Siluro	15x44	Alogena	Stella Polare 24V. 112,5° - 125°	-				
	L 08 10 024	24	10	Siluro	11x44	Alogena	Stella Polare 24V. 135°	Croce del Sud				

Foto Picture	Articolo Item	Volt	Watt	Attacco Fitting	↑ → mm.	Tipo-Type	Montata di serie Standard fitted	Per fanale For light	Box	€/pc.	€/box	kg.
Lampadine BA15D - BA15D blubs												
	L 08 12 010	12	10	BA15D	15	Alogena	Pole 360°	-				
	L 08 24 010	24	10	BA15D	15	Alogena	-	Pole 360°				





Lampadine a led SMD

Sostituiscono tutte le lampadine alogene da 10 watt con attacco laterale. Generano una luminosità pari alla alogena da 10 Watt con una durata di 10.000 ore.

Bulbs with SMD leds

Suitable to replace the halogen bulbs 10 watt with side fitting. They can generate the same lighting of halogen bulbs 10 watt with a working time of 10.000 hours.

Articolo - Item	Attacco Fitting	Ø chip mm.	Volts	Watts	Watts equivalenti Equivalent watts	Light Bulb Led	Luce - Light	Lumens	€/pc.	kg.
L 44 06 023	G4 laterale	23	9 - 32	1,8	7	A - 6	Fredda - Cold	70		0,010
L 44 09 028	G4 laterale	28	9 - 32	1,8	15	B - 9	Fredda - Cold	130		0,010
L 44 12 030	G4 laterale	30	9 - 32	1,5	20	C - 12	Fredda - Cold	130		
L 43 06 023	G4 laterale	23	9 - 32	1,8	7	A - 6	Calda - Warm	70		0,010
L 43 09 028	G4 laterale	28	9 - 32	1,8	15	B - 9	Calda - Warm	130		0,010
L 43 12 030	G4 laterale	30	9 - 32	1,5	20	C - 12	Calda - Warm	130		

Lampadine al led SMD zoccolo BA15D per faretti

Led bulbs SMD base BA15D for spotlights



Articolto - Article	Luce Light	Light Bulb Led	Volts	Watts equivalenti	Watts equivalent	Lumens	mm.	€/pc.	kg.
L 44 12 156	Calda Warm	13	12/24	2	12	156	Ø16x41L		
L 44 00 156	Fredda Cold	13	12/24	2	12	156	Ø16x41L		



Lampadine al led SMD zoccolo BA15D per faretti con copertura in resina

Led bulbs SMD base BA15D for spotlights with resin covering



Articolto - Article	Luce Light	Light Bulb Led	Volts	Watts equivalenti	Watts equivalent	Lumens	mm.	€/pc.	kg.
L 44 00 200	Calda Warm	48	12/24	2,5	20	200	Ø13x40L		
L 44 20 200	Fredda Cold	48	12/24	2,5	20	200	Ø13x40L		



Lampadine al led BAY15D perni disassati per fanali di via con copertura in resina

Led bulbs BAY15D with pins out of axis for navigation lights with resin covering



Articolto - Article	Luce Light	Light Bulb Led	Volts	Watts equivalenti	Watts equivalent	Lumens	mm.	€/pc.	kg.
L 44 20 215	Calda Warm	48	12/24	2,5	20	200	Ø13x40L		
L 44 00 215	Fredda Cold	48	12/24	2,5	20	200	Ø13x40L		



Lampadine a siluro al led

Provviste di led con irraggiamento totale sui 360°.

Led festoon bulbs

With 360° lighting leds.

Articolo - Item	Mod.	mm.	Volts	Watt	Chip	Light Bulb Led	Adatta per fanali Suitable for lights	Luce Light	€/paio	kg.
L 44 10 031 B	A	31	12	0,8	12	4	-	Fredda - Cold		0,010
L 44 10 039 B	B	39	12	1,7	24	8	Mini Star Orsa Minore	Fredda - Cold		0,010
L 44 10 044 B	C	44	12	2,4	36	12	Croce del Sud Stella Polare	Fredda - Cold		0,010
L 43 10 039 B	B	39	12	1,7	24	8	Mini Star Orsa Minore	Calda - Warm		0,010
L 43 10 044 B	C	44	12	2,4	36	12	Croce del Sud Stella Polare	Calda - Warm		0,010





Ciabatta Cee - «Schuko» a 4 prese con coperchio Extension 4 "Schuko" outlets lead with cover

Provvista di cavo in neoprene 3 x 1,5 mm². 16A.

Provided with neoprene cable 3 x 1,5 mm². 16A.

Articolo - Item	Modello Model	mt.	€/pc.	kg.
Z 20 46 503	Mini	1,5		1,060



NEW

Ciabatta a 3 prese e porta usb Three way and USB socket

Articolo - Item	Modello - Model	mt.	€/pc.	kg.
Z 20 03 015	H07RN-F3G 1,5mm ²	1,5		



Adattatori 16A 40cm cavo: H07RN-F3G 1.5mmq 230V AC Adaptor 16A 230V AC Cable: H07RN-F3G 1.5mmq - 40cm long

Articolo - Item	Modello - Model	€/pc.	kg.
Z 20 82 035	«Schuko» - Cee		0,240



Contenitore impermeabile per prolunghe Waterproof holder for extension lead

Articolo - Item	mm.	€/pc.	kg.
Z 20 82 043	380 x 90		0,320



Impugnatura per cavi Cable Wraptor

Articolo - Item	mm.	€/pc.	kg.
Z 20 02 090	180 x 90		0,080



Arrotolatore per cavi e tubi con maniglia e per il trasporto Cable and hose wraptor with handle

Articolo - Item	mm.	€/pc.
Z 20 01 090	378 x 168 x 67	



Prolunga in cavo di neoprene 16A, IP44 Extension lead in neoprene IP44, 16A

Spina e presa Cee-Cee.

Cee-Cee.

Articolo - Item	Modello - Model	mt.	€/pc.	kg.
Z 20 82 024	H07RN-F3G 1,5 mm ²	10		1,750
Z 20 05 092	H07RN-F3G 1,5 mm ²	25		5,200
Z 20 82 018	H07RN-F3G 2,5 mm ²	10		2,300
Z 20 82 181	H07RN-F3G 2,5 mm ²	25		6,700
Z 20 00 010	Sacca per-Bag for 10mt.			
Z 20 00 025	Sacca per-Bag for 25mt.			



Prolunga CEE 3x2, 5mmq. 230V AC IP44, 16A, cavo 150cm

IP44 Extension lead CEE 3x2,5mmq. 230V AC, 16A, 150cm cable

Articolo Item	Spina tipo Plug type	Accoppiatore Coupler	€/pc.	kg.
Z 20 08 180	CEE	CEE		0,600
Z 20 08 270	Schuko	CEE		0,400
Z 20 82 022	CEE	Schuko		0,500



Presse Economy Cee con coperchio IP44 Economy Cee socket with cover 230V AC

Articolo - Item	Amp.	mm.	€/pc.	kg.
Z 20 01 000	16	130 x 60		0,120



Spina Cee Economy IP44 IP44 Economy Coupler Cee 230V AC

Articolo - Item	Amp.	mm.	€/pc.	kg.
Z 20 01 100	16	138 x 70		0,140



Presse a gomito CEE/Schuko Hooked coupler CEE/Schuko 200-250V AC 220-240V AC

Articolo - Item	Amp.	mm.	€/pc.	kg.
Z 20 82 030	16	Ø 50 x 90 x 115 H		0,160



Presse a parete con coperchio Cee IP44 Outlet surface Cee 200-250V AC 50-60Hz IP44 200-250V AC 50-60Hz

Articolo - Item	Amp.	mm.	€/pc.	kg.
Z 20 02 000	16	148 x 87 x 85		0,180



Presse volante con coperchio Cee IP44 Coupler 32A Cee 230V AC 50-60Hz 230V AC 50-60Hz

Articolo - Item	Amp.	mm.	Ideale per cavo - For cable Ø mm.	€/pc.	kg.
Z 20 01 105	32	160 x 65	6 / 12		0,220



Spina volante Cee IP44 Plug Cee 230V AC 50-60Hz IP44 230V AC 50-60Hz

Articolo - Item	Amp.	mm.	Ideale per cavo - For cable Ø mm.	€/pc.	kg.
Z 20 01 005	32	160 x 95	6 / 12		0,170



Spina Cee a parete IP44 IP44 Inlet surface Cee 230V AC 50-60Hz 230V AC 50-60Hz

Articolo - Item	Amp.	mm.	Ideale per cavo - For cable Ø mm.	€/pc.	kg.
Z 20 01 205	32	160 x 80 x 84	11 / 18		0,180



Spina di corrente a 7 poli **PVC plug 7 poles**

Articolo - Item	Modello - Model	kg.	€/pc.
Z 20 05 197	12V.	0,080	

Pres a fissa a 7 poli con coperchio **PVC socket 7 poles with cover**

Articolo - Item	Modello - Model	kg.	€/pc.
Z 20 04 217	12V.	0,080	

Spina di corrente a 13 poli **Plug 13 poles**

Articolo - Item	Modello - Model	kg.	€/pc.
Z 20 01 013	12V.	0,140	

Pres a fissa a 13 poli con coperchio **Socket 13 poles with cover**

Articolo - Item	Modello - Model	kg.	€/pc.
Z 20 12 013	12V.	0,100	

Microadattatore **Microadaptor**

Spina 13 poli + presa 7 poli 12V. 13 pins, 7 plugs. 12V.

Articolo - Item	Modello - Model	kg.	€/pc.
Z 20 40 403	12V.	0,080	



A



B

Adattatori di corrente per carrelli
Adaptor for boat carrier

Articolo - Item	Tipo Type	Modello - Model	kg.	€/pc.
Z 20 13 007	A	da spina a 13 poli a presa 7 from pin 13 poles to plug 7	0,120	
Z 20 07 013	B	da spina a 7 poli a presa 13 from pin 7 poles to plug 13	0,070	



Presa 12V. auto (tipo accendisigari). Socket 12V. for car (cigarette lighter).

Articolo - Item	Colore - Colour	kg.	€/pc.
Z 20 79 120	■ Grigio-Grey		
Z 20 86 120	■ Marrone-Brown		



Presa 12V. standard. Socket 12V. standard.

Articolo - Item	Colore - Colour	kg.	€/pc.
Z 20 79 012	■ Grigio-Grey		



Presa 12V. auto (tipo accendisigari) con coperchio stagno. Socket 12V. for car (cigarette lighter) with waterproof cover.

Articolo - Item	Colore - Colour	kg.	€/pc.
Z 20 12 286	■ Marrone-Brown		



Presa 12V. auto (tipo accendisigari) con coperchio. Socket 12V. for car (cigarette lighter) with cover.

Articolo - Item	Colore - Colour	kg.	€/pc.
Z 20 79 121	■ Grigio-Grey		
Z 20 86 121	■ Marrone-Brown		



Presa TV (TV 9,5 75 Ohm). TV socket (TV 9,5 75 Ohm).

Articolo - Item	Colore - Colour	kg.	€/pc.
Z 20 86 095	■ Marrone-Brown		



Presa TV + SAT (TV 9,5 75 Ohm SAT F 75 Ohm). TV + SAT socket (TV 9,5 75 Ohm SAT F 75 Ohm).

Articolo - Item	Colore - Colour	kg.	€/pc.
Z 20 86 275	■ Marrone-Brown		



Presa 12V. + TV (TV 9,5 75 Ohm). Socket 12V. + TV (TV 9,5 75 Ohm).

Articolo - Item	Colore - Colour	kg.	€/pc.
Z 20 95 079	■ Grigio-Grey		
Z 20 95 086	■ Marrone-Brown		



Presa 230V. italiana con coperchio completa di scatola di protezione. Socket 230V. with cover and protection box.

Articolo - Item	Colore - Colour	kg.	€/pc.
Z 20 86 230	■ Marrone-Brown		



Presa 12V. auto + TV (TV 9,5 75 Ohm). Socket 12V. car + TV (TV 9,5 75 Ohm).

Articolo - Item	Colore - Colour	kg.	€/pc.
Z 20 79 075	■ Grigio-Grey		



Presa 12V. standard + TV + SAT (TV 9,5 75 Ohm). Socket 12V. standard + TV + SAT (TV 9,5 75 Ohm).

Articolo - Item	Colore - Colour	kg.	€/pc.
Z 20 75 086	■ Marrone-Brown		



Presse 230V. «Schuko» standard tedesca con coperchio completa di scatola di protezione.

Socket 230V. 230V. «Schuko» with cover complete with protection box.

Articolo - Item	Colore - Colour	kg.	€/pc.
Z 20 22 079	■ Grigio-Grey		*
Z 20 22 086	■ Marrone-Brown		*



Alto-High



Scatola di protezione ridotta.

Reduced protection box.

Articolo - Item	Ø mm.	← mm.	kg.	€/pc.
Z 20 50 034	50	34		



Modulo 4 fusibili. 4 Fuses module

Articolo - Item	Colore - Colour	kg.	€/pc.
Z 20 33 079	■ Grigio-Grey		*



Distanziale per montaggio interruttore a parete 60 x 60 x 10 mm.

Spacer for wall mounting 60 x 60 x 10 mm.

Articolo - Item	Colore - Colour	kg.	€/pc.
Z 20 34 079	■ Grigio-Grey		



Cornice 1 modulo 60 x 60 x 10 mm.

Frame 1 module 60 x 60 x 10 mm.

Articolo - Item	Colore - Colour	kg.	€/pc.
Z 20 79 060	■ Grigio-Grey		
Z 20 86 060	■ Marrone-Brown		



Portafusibile mega

+ fusibile 50A.
Completo di capo-corda.

Fuse holder mega

+ fuse 50A.
Complete with lug.

Articolo - Article	€/pc.
Z 20 45 750	



Cornice CBE 1 modulo 86 x 78 x 10 mm.

Frame CBE 1 module 86 x 78 x 10 mm.

Articolo - Item	Colore - Colour	kg.	€/pc.
Z 20 79 086	■ Grigio-Grey		*
Z 20 86 086	■ Marrone-Brown		*



Cornice CBE 2 moduli, 78 x 140 mm.

Frame CBE 2 modules, 78 x 140 mm.

Articolo - Item	Colore - Colour	kg.	€/pc.
Z 20 79 160	■ Grigio-Grey		*
Z 20 86 160	■ Marrone-Brown		*

* Disponibile su richiesta - Available on request

Spine, prese e interruttori «CBE» - Plugs, sockets and switches «CBE»



Interruttore unipolare. Unipolar switch.

Articolo - Item	Colore - Colour	kg.	€/pc.
Z 20 20 079	■ Grigio-Grey		
Z 20 20 086	■ Marrone-Brown		



Interruttore 12V. + Led. Switch 12V. + Led.

Articolo - Item	Colore - Colour	kg.	€/pc.
Z 20 24 086	■ Marrone-Brown		

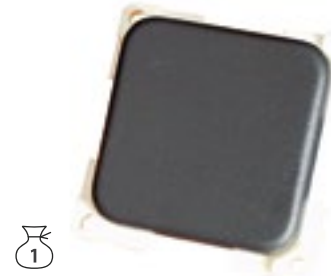

Deviatore unipolare. Two ways switch.

Articolo - Item	Colore - Colour	kg.	€/pc.
Z 20 21 086	■ Marrone-Brown		



Interruttore unipolare doppio. Double unipolar switch.

Articolo - Item	Colore - Colour	kg.	€/pc.
Z 20 23 086	■ Marrone-Brown		



Interruttore gradino a 3 posizioni. Switch 3 positions.

Articolo - Item	Colore - Colour	kg.	€/pc.
Z 20 27 086	■ Marrone-Brown		



Interruttore doppio pompa e luci. Switch pumps & lights

Articolo - Item	Colore - Colour	kg.	€/pc.
Z 20 31 079	■ Grigio-Grey		*



Interruttore 12V. + Led. Switch 12V. + Led

Articolo - Item	Colore - Colour	kg.	€/pc.
Z 20 25 079	■ Grigio-Grey		
Z 20 25 086	■ Marrone-Brown		



Interruttore 12V. doppio. Double switch 12V.

Articolo - Item	Colore - Colour	kg.	€/pc.
Z 20 26 086	■ Marrone-Brown		



Interruttore gradino con deviatore luce 12/24V. Switch 12/24V.

Articolo - Item	Colore - Colour	kg.	€/pc.
Z 20 28 079	■ Grigio-Grey		

Interruttori - Switches

- > Confezione in sacchetto da 6 pezzi
- > Packing in polybag of 6 pcs.

Interruttore luminoso rosso 12V. Red light switch 12V.

Adatto per frigo trivalente. Suitable for trivalent refrigerator

Articolo - Article	€/pc.
Z 20 00 237	*



* Disponibile su richiesta - Available on request

Passaggio cavi - Roof duct



Kit passaggio cavi

Kit 1 via per il passaggio cavi (per guaina Ø 12 mm.).
Per tetti spessore max. 60 mm.
Confezione singola.

1- exit roof duct

For 12 mm. Ø sheath.
For maximum roof thickness of 60 mm.
Single packing.

Articolo - Article
L 15 07 200

€/pc.

Tester pannello solare Tester for solar panel



Pannello test

Pannello test per il controllo della tensione di batteria e della corrente erogata dal pannello solare. Completo di cavo lunghezza 1,5 metri, distanziale per fissaggio a parete e cornice.
Confezione singola.

Solar test

Test panel for the control of battery voltage and current supplied by the solar panel. The kit includes a cable 1,5m long, a wall-fixing spacer and a frame.
Single packing.

Articolo - Article
L 15 79 542
L 15 86 542

Colore - Colour
Grigio - Grey
Marrone - Brown

€/pc.

Kit supporto pannelli Supporting kit for panels



Kit supporto pannelli solari

Composto da 4 supporti in plastica per fissare qualsiasi tipo di pannello solare su tutti i piani di carico del camper.
Confezione in sacchetto da 4 kit.

Supporting kit for solar panels

Kit including 4 plastic supports suitable to fix every model of solar panel on the luggage racks of the motorhome.
Packing in polybag of 4 kits.

Articolo - Article
O 30 60 427

€/Kit 4 pezzi - Kit of 4 pcs.

Tester batterie - Battery tester



«Battery Tester»

Realizzato in Abs.
Bassa: 5-11,7V. (12V.) - 16-23,5V. (24V.)
Media: 11,8-12,47V. (12V.) - 23,6-24,9V. (24V.)
Alta: 12,5-15,9V. (12V.) - 25-30V. (24V.)
Confezione singola.

«Battery Tester»

Manufactured in Abs.
Low: 5-11,7V. (12V.) - 16-23,5V. (24V.)
Medium: 11,8-12,47V. (12V.) - 23,6-24,9V. (24V.)
High: 12,5-15,9V. (12V.) - 25-30V. (24V.)
Single packing.

Articolo - Article
L 15 01 341
L 15 21 341

Modello - Model

A - presa accendisigari - Cigar-lighter
B - con morsetti batteria - Battery clamps

€/pc.

Morsetti staccabatterie - Circuit breakers



Morsetto stacca batterie «on-off» modello antifurto

Con una rotazione del pomello si disinserisce il contatto elettrico sul polo +.
Rimuovendo il pomello si ottiene una efficace azione antifurto.
Confezione in blister e in sacchetto da 10 pezzi.

Circuit breaker, antitheft model «on-off»

Releasing of electrical contact on pole + by rotating of the knob.
Anti-theft activated when the knob is removed.
Packing in blister and in polybag of 10 pcs.

Articolo - Article
L 20 03 007

gr.
140

€/pc.



Coppia morsetti per batteria serie «Extra» positivo e negativo

Confezione SELF-SERVICE. Fabbricati in ottone.
Confezione in sacchetto da 1 coppia e in sacchetto da 10 coppie.

Pair of clamps for battery «Extra» series + and -

SELF-SERVICE packing
Made of brass.

Packing in polybag of 1 pair and in polybag of 10 pairs.

Articolo - Article
L 20 06 000

gr.
240

€/Paio - Pair

Portafusibili - Fuse box



Portafusibile 50A.

+ 2 fusibili a piastrina.
Completo di capocorda.

Fuse holder 50A.

+ 2 fuses.
Complete with lug.

Articolo - Article
Z 20 00 450

€/pc.

Cassette batteria - Battery boxes



80A



made by TREM

Cassetta portabatteria o porta attrezzi mod. «Octopus» in resistente materiale plastico

Dotata di cinghia per la chiusura del coperchio e fibbia di regolazione. Colore rosso e bianco.

Battery-holder or tool holder mod. «Octopus» in strong plastic material

Complete with carrying strap and nylon buckle for fastening. Red and white colour.

Articolo - Item	↳ mm.	€/pc.	📦 kg.
N 01 38 120	190 x 270 x 200 H		1,200



100A



made by TREM

Cassette portabatteria per batterie 100A. mod. «Koala» in polipropilene antiurto

Colore nero. Munita di cinghia con fibbia di regolazione per la chiusura del coperchio.

Battery-holder for 100A. battery mod. «Koala» in shockproof polypropylene

Complete with carrying strap and nylon buckle for fastening. Black colour.

Articolo - Item	↳ interne mm.	€/pc.	📦 kg.
N 01 43 260	185 x 355 x 263 H		1,250

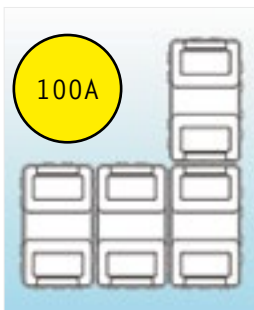

100A



made by TREM

Cassetta per batterie 100A. mod. «Combi» in resistente materiale plastico

Modello che consente di unire più cassette tra loro. Dotata di cinghia per la chiusura del coperchio e fibbia di regolazione. Colore bianco e blu. Componibile in larghezza e in lunghezza.

MODELLO COMPONIBILE COMPONIBLE MODEL

Battery-holder for 100A. battery mod. «Combi» in shockproof polypropylene

Complete with carrying strap and nylon buckle for fastening. White and blue colour. Modular in width and length.

Articolo - Item	↳ mm.	€/pc.	📦 kg.
N 01 14 546	197 x 337 x 268 H		1,250



made by TREM

Cassette portabatteria e porta attrezzi con separatore interno regolabile mod. «Kanguro»

Indicata per contenere 1 batteria grande. Fabbricata in polipropilene antiurto. Munita di cinghia con fibbia di regolazione per la chiusura del coperchio.

Battery holder and tool holder mod. «Kanguro» with adjustable partition

Can hold a big or 2 little batteries. Suitable also as boards equipment holder. Manufactured in polypropylene antichoc. With adjustable belt.

Articolo - Item	↳ mm.	€/pc.	📦 kg.
N 01 41 250	200 x 410 x 200 H		1,300

140A

Accessori batterie - Battery accessories



made by TREM

Doppia piastra fissa batteria o serbatoio

Fabbricata in plastica, completa di cinghia per il fissaggio sul pagliolo e di fibbia per la regolazione.

Double bracket for battery box or fuel tank fixing

Manufactured in plastic. With fastening belt.

Articolo - Item	Modello - Model	€/kit	📦 kg.
N 01 00 180	Universal		0,180

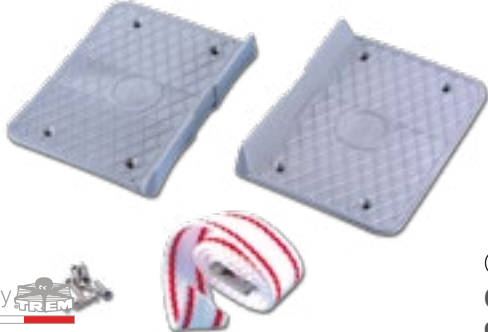

made by TREM

Cinghia fermaserbatoio o batteria

Cinghia completa di fibbie di regolazione e di due ponticelli da applicare sul fondo dell'imbarcazione. Con viti autofilettanti.

Complete set for fastening battery box or auxiliary jerrycan for gasoline

Belt complete with adjusting buckle. Supplied with self-threading screws.

Articolo - Item	←→ cinghia-belt mm.	€/pc.	📦 kg.
N 01 40 000	1360		0,030



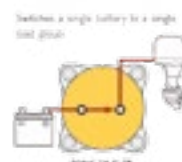

Staccabatteria «Mini» 300A . a chiave e pomello

Montaggio esterno o ad incasso. Realizzato in policarbonato rinforzato. Leva di comando sfilabile. Terminali di generose dimensioni in rame argentato stampati a caldo. Contatti in rame argentato.

Battery switch «Mini» 300A. with key and knob

Made of reinforced polycarbonate. Case design allows surface, rear, or front panel mounting options. Removable key. Tin-plated copper studs for maximum conductivity and corrosion resistance.

Articolo - Item	Mod.	Potenza continua Continuous rating	Potenza interm. Intermittent rating 5 min.	Potenza 10 sec. 10 sec. rating	Tensione Voltage	Poli interr N. Poles N.	Sezione perni Pins	Foro incasso Hole mm.	mm.	kg.	€/pc.
K 06 06 005	A-6005B	300A	500A	1500A	48V	1	M10	60,33	71,76x71,76 x77,94	0,280	
K 06 06 006	B-6006B	300A	500A	1500A	48V	1	M10	60,33	71,76x71,76 x77,94	0,290	



Deviatore «Mini» 0-1-2 BOTH

Montaggio esterno o ad incasso. Realizzato in policarbonato rinforzato. Contatti in rame argentato.

Single circuit ON-OFF

Made of reinforced polycarbonate. Surface, rear, or front panel mounting options. Switches a single battery to a single load group.

Articolo - Item	Mod.	Potenza continua Continuous rating	Potenza interm. Intermittent rating 5 min.	Potenza 10 sec. 10 sec. rating	Tensione Voltage	Poli interr N. Poles N.	Sezione perni Pins	Foro incasso Hole mm.	mm.	kg.	€/pc.
K 06 06 007	6007B	300A	500A	1500A	32V	1	M10	60,33	71,76x71,76 x77,94	0,350	

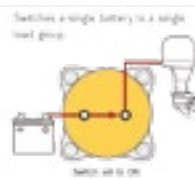

Staccabatteria Maxi 350A .

Montaggio esterno o ad incasso. Realizzato in policarbonato rinforzato. Terminali di generose dimensioni in rame argentato stampati a caldo. Contatti in rame argentato.

Battery switch «Maxi» 350A.

Made of reinforced polycarbonate. Surface, rear, or front panel mounting options. Switches a single battery to a single load group. Terminal studs made of tin-plated copper.

Articolo - Item	Mod.	Potenza continua Continuous rating	Potenza intermittente Intermittent rating 5 min.	Potenza 10 sec. 10 sec. rating	Tensione Voltage	Poli interr N. Poles N.	Sezione perni Pins	Foro incasso Hole mm.	mm.	kg.	€/pc.
K 06 09 003	9003eB	350A	600A	2000A	48V	1	M10	92,08	97,79x97,79 x78,67	0,590	

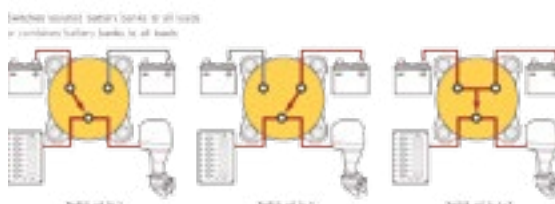

Deviatore Maxi 0 - 1 - 2 Both

Realizzato in policarbonato rinforzato. Montaggio esterno o ad incasso. Contatti in rame argentato.

Selector 4 position

Made of reinforced polycarbonate. Surface, rear, or front panel mounting options. Terminal studs made of tin-plated copper.

Articolo - Item	Mod.	Potenza continua Continuous rating	Potenza intermittente Intermittent rating 5 min.	Potenza 10 sec. 10 sec. rating	Tensione Voltage	Poli interr N. Poles N.	Sezione perni Pins	Foro incasso Hole mm.	mm.	kg.	€/pc.
K 06 09 001	9001eB	350A	600A	2000A	32V	1	M10	92,08	97,79x97,79 x78,67	0,590	



Interruttore - deviatore per batterie carico 175A. CC e 300A. AC

Permette di usare alternativamente o insieme o staccare le batterie. 175A. CC, 300A. alternata.

Battery switch load 175A. CC and 300A. AC

Provides selections between either of two sets of batteries operation of both in parallel or complete disconnection of batteries from all circuits.

Articolo - Item	mm.	Volts	kg.	€/pc.
L 06 12 120	135 x 135 x 70 H	6 - 12 24 - 32	0,460	

Cavi batteria - Battery cables



Cavo batterie flessibili H07V-K

Tensione nominale 100V.
Trefoli in rame sottilissimi per la massima flessibilità.
Guaina esterna in neoprene siliconico (impermeabilità al salino).

Flexible battery cable H07V-K

Nominal voltage rating 100V.
Copper leaves for a higher flexibility.
Outer sheath manufactured in Neoprene.

Articolo - Item	N. conduttori Threads N.	Sezione cavo Cable section mm ²	Colore guaina Sheath colour	Spessore isolante Insulating thickness mm.	Resistance 20°C Ohm/Km.	Portata-Load 30°C A	Matassa-Reel mt.	kg.	€/
L 15 80 016	1x	16	Nero-Black	1,6	1,21	76	25	4,200	
L 15 82 016	1x	16	Rosso-Red	1,6	1,21	76	25	4,200	
L 15 80 025	1x	25	Nero-Black	1,8	0,78	101	25	6,500	
L 15 82 025	1x	25	Rosso-Red	1,8	0,78	101	25	6,500	
L 15 80 035	1x	35	Nero-Black	1,8	0,55	125	25	8,500	
L 15 82 035	1x	35	Rosso-Red	1,8	0,55	125	25	8,500	
L 15 80 050	1x	50	Nero-Black	1,8	0,38	151	25	12,500	
L 15 82 050	1x	50	Rosso-Red	2,2	0,38	151	25	12,500	
L 15 80 070	1x	70	Nero-Black	2,2	0,27	192	25	16,800	
L 15 82 070	1x	70	Rosso-Red	2,2	0,27	192	25	16,800	

Staccabatteria - Circuit breakers



Mini staccabatteria 12V. (250A CC e 350A AC)

Di dimensioni ridottissime ma con portata di 250 A. a corrente continua e 350 A. in alternata. Modelli fabbricati in plastica Tenuta stagna. Adesivo fosforescente per la visione notturna. Confezione in scatola singola.

Mini circuit-breaker 12V. (250A CC e 350A AC)

Very small size. Maxi load up to 250 A. CC and 350 A. AC. Made of anticorodal plastic material. Waterproof. With glow light adhesive for night vision. Single packing in box.

Articolo - Article	Tipo Type	Mod.	↑ mm.	€/pc.
L 06 00 092	A	con interruttore with switch	68 x 68	
L 06 00 093	B	con chiave asportabile with key	68 x 68	

Mini deviatore

portata di 250 A. a corrente continua e 400 A. in alternata. Modelli fabbricati in plastica. Tenuta stagna. Adesivo fosforescente per la visione notturna. Confezione singola e in scatola da 6 pezzi.

Mini circuit breaker

Capacity 250 A. continuous or 400 A. intermittent. Waterproof. Manufactured in plastic. Fluorescent body. Single packing and box of 6 pcs.

Articolo - Article	Modello - Model	↑ mm.	€/pc.
L 06 10 192	con interruttore - with switch	68 x 68	

Coppia morsetti per batteria

Confezione in sacchetto da 1 coppia.

Pair of clamps for battery

Packing in polybag of 1 pair..

Articolo - Article	Filetto - Threading	€/Paio - Pair
L 15 00 020	6	
L 15 00 025	8	



Staccabatteria 100A. grado di protezione IP43 (IEC 529)

In materiale plastico completo di chiave. Contatti in rame argentato, molle e terminale in acciaio inox. Per 6, 12 e 24V. Capacità 150A. in corrente continua (DC) e 1200A. per 5 sec. Contatti M10. Confezione in scatola singola e in Master Carton da 20 pezzi.

Battery switch 100A. IP43 (IEC 529)

In plastic material with key. Silver-plated copper contacts and stainless steel springs. Suitable for 6, 12 and 24V. Capacity 150A. in continuous (DC) and 1200A. for 5 sec. M10 contacts. Single packing in box and in Master Carton of 20 pcs.

Articolo - Article	Ø mm.	Altezza - Height mm.	gr.	€/pc.
L 06 13 065	57,5	104	85	
L 06 13 066	Chiave di ricambio con guarnizione PVC Spare key with PVC gasket			



Pannello opzionale - Optional remote display for battery charger

Articolo - Item €/pc.
L 06 80 761 49,20



Caricabatterie

Confezione singola.

Articolo - Item	Battery charger
Modello-Model	L 06 80 295 BC-1220SCT
Potenza Max./Max power	20A
Uscite/Outputs	2
Capacità batteria cons./Suggested battery capacity	40-200Ah
Diametro cavo cons./Suggested cable diameter	4 mm
Ventilatore/Ventilator	Aeratore a temperatura comandata/Controlled temperature aerator
Tensione d'uscita/Output voltage	14,2/14,6/14,8 VDC
Tensione di mantenimento/Maintenance	13,2/13,5/13,8 VDC
Tensione d'entrata/Input Voltage 50/60Hz	120-230 Volt AC +/- 15 50/60Hz
Uscita cortocircuito/Short circuit output	si
Indicatori Led/Led indicators	Verde-In funzione/Green-Working signal, Giallo-Assorbimento/Yellow-Input, Rosso-Carico/Red-Charge
Temperatura in funzione/Temperature in operation	0-40 C
Peso-Weight kg.	1,275 kg.
Dimensioni-Size mm. L x P x H	240X145X80
€/pc.	

Inverters onda pura - Pure sine wave inverter



Inverter onda pura

Protezioni: sovraccarico, surriscaldamento, sovratensione in entrata, basso voltaggio in entrata e uscita, cortocircuito.

Pure sine wave inverter

Protection specifications: Overload, Overheat, Input Overvoltage, Input Lowvoltage and Output Short-circuit protection.



12V.

► Pure sine wave

Articolo - Item	L 06 08 150
Modello-Model	1500W-12V
Voltaggio in entrata-Input Voltage	DC 12V
Voltaggio in uscita-Output Voltage	AC 220V-240V/AC 110V-120V
Potenza continua-DC current	1500W
Potenza di picco-Peak current	3000W
Frequenza di uscita-Exit frequency	50Hz.
Peso-Weight kg.	2,50 kg.
Dimensioni-Size mm. L x P x H	335x203x78
USB	DC 5V 500mA
Distorsione-Distortion	<3%
€/pc.	

Inverters onda modificata - Modified sine wave inverters



12V.



A

► Fusibili sostituibili
Replaceable fuses

Inverter onda modificata

Protezioni: sovraccarico, surriscaldamento, sovratensione in entrata, basso voltaggio in entrata e uscita, cortocircuito. Frequenza d'uscita: 50 +/-3 Hz. USB DC 5V (0,5A,1A,2,1A)

Modified sine wave inverter

Protection specification: Overload, Overheat, Input Overvoltage, Input Lowvoltage and Output Short-circuit protection. Frequency: 50 +/-3 Hz. USB DC 5V (0,5A,1A,2,1A)

Articolo - Item	L 06 12 300
Modello-Model	A 300 W - 12V
Voltaggio in entrata-Input Voltage	DC 12V
Voltaggio in uscita-Output Voltage	AC 230V AC +/- 10%
Potenza continua-DC current	300 W
Potenza di picco-Peak current	600 W
Peso-Weight kg.	10,500
Dimensioni-Size mm. L x P x H	222x115x65
€/pc.	

* Disponibile su richiesta - Available on request

Inverters onda modificata - Modified sine wave inverters

Inverter onda modificata

Protezioni: sovraccarico, surriscaldamento, sovratensione in entrata, basso voltaggio in entrata e uscita, cortocircuito. Frequenza d'uscita: 50 +/-3 Hz. USB DC 5V (0,5A,1A,2,1A)

Articolo - Item	L 06 12 600
Modello-Model	B 600W-12V
Voltaggio in entrata-Input Voltage	DC 12V
Voltaggio in uscita-Output Voltage	AC 230V AC +/- 10%
Potenza continua-DC current	600W
Potenza di picco-Peak current	1200W
Peso-Weight kg.	12,800
Dimensioni-Size mm. L x P x H	228x115x65
€/pc.	



12V.



B

►Fusibili sostituibili
Replaceable fuses

Inverter onda modificata

Protezioni: sovraccarico, surriscaldamento, sovratensione in entrata, basso voltaggio in entrata e uscita, cortocircuito. Frequenza d'uscita: 50 +/-3 Hz. USB DC 5V (0,5A,1A,2,1A)

Articolo - Item	L 06 22 100
Modello-Model	C 1000W-12V
Voltaggio in entrata-Input Voltage	DC 12V
Voltaggio in uscita-Output Voltage	230V AC +/-10%
Potenza continua-DC current	1000W
Potenza di picco-Peak current	2000W
Peso-Weight kg.	11,000
Dimensioni-Size mm. L x P x H	255x185x85
€/pc.	



12V.



C

►Fusibili sostituibili
Replaceable fuses

Inverter onda modificata

Protezioni: sovraccarico, surriscaldamento, sovratensione in entrata, basso voltaggio in entrata e uscita, cortocircuito. Frequenza d'uscita: 50 +/-3 Hz. USB DC 5V (0,5A,1A,2,1A)

Articolo - Item	L 06 22 150	L 06 30 150
	Modello-Model	D 1500W-12V
Voltaggio in entrata-Input Voltage	DC 12V	24V DC
Voltaggio in uscita-Output Voltage	230V AC +/-10%	230V AC +/-10%
Potenza continua-DC current	1500W	1500W
Potenza di picco-Peak current	3000W	3000W
Peso-Weight kg.	14,000	14,000
Dimensioni-Size mm. L x P x H	270x165x70	270x165x70
€/pc.		



12-24V.



D



Inverter onda modificata

Protezioni: sovraccarico, surriscaldamento, sovratensione in entrata, basso voltaggio in entrata e uscita, cortocircuito. Frequenza d'uscita: 50 +/-3 Hz. USB DC 5V (0,5A,1A,2,1A)

Articolo - Item	L 06 22 200	L 06 40 200
	Modello-Model	E 2000W-12V
Voltaggio in entrata-Input Voltage	DC 12V	24V DC
Voltaggio in uscita-Output Voltage	230V AC +/-10%	230V AC +/-10%
Potenza continua-DC current	2000W	2000W
Potenza di picco-Peak current	4000W	4000W
Peso-Weight kg.	12,100	12,100
Dimensioni-Size mm. L x P x H	380x218x100	380x218x100
€/pc.		



12-24V.



E





Spina accendisigari USB

Tensione ingresso: 12-24VDC.

Charger USB type

Input Voltage 12-24VDC.

Articolo - Item	USB Port	↑ mm.	€/pc.	kg.
L 06 01 342	1	∅ 26x40		0,020
L 06 02 348	2	63x39x36		0,050



Spina accendisigari con 3 porte USB

Ideale per iPhone, iPod, iPad, altri tablets.

3 USB Port charger

Suitable for iPhone, iPod, iPad, other tablets.

Articolo - Item	Volts	Amps.	€/pc.	kg.
L 06 00 785	12	max 4,8		11,52



Presca accendisigari montaggio a vite

Fabbricata in nylon nero.

Cigarette lighter connector

Manufactured in black nylon.

Articolo - Item	↑ mm.	Prese Sockets	€/pc.	kg.
L 06 01 335	∅ int. 20	1		0,050



Presca 2 porte usb

2 Port USB Socket

Articolo - Item	Colore Colour	Amp.	€/pc.	kg.
L 06 02 435	Black	2,1 + 1		0,040
L 06 74 435	White	2,1 + 1		



Presca 2 porte usb + 1 presa accendisigari

Power + 2 Port USB socket

Articolo - Item	Colore Colour	Amp.	€/pc.	kg.
L 06 03 028	Black	2,1 + 1		
L 06 74 516	White	2,1 + 1		



Voltmetro

Voltmeter socket

Articolo - Item	€/pc.	kg.
L 06 10 595		



Voltmetro e amperometro

Voltmeter and current

Articolo - Item	€/pc.	kg.
L 06 10 601		



Presca accendisigari, voltmetro, amperometro

Power socket, voltmeter and current

Articolo - Item	€/pc.	kg.
L 06 10 600		



Presca accendisigari, voltmetro, amperometro, 2 porte usb

Voltmeter and current, 2 Port USB socket and power socket

Articolo - Item	Amp.	€/pc.	kg.
L 06 10 599	2,1 + 1		



Preso e spina con attacco accendisigari 12V.

Fabbricata in policarbonato nero.

Socket and cigarette lighter plug 12V.

Manufactured in black polycarbonate.

Articolo - Item	Tipo-Type	Modello - Model	€/pc.	kg.
L 06 01 332	A	Preso doppia - Double socket		0,070
L 06 00 191	B	Spina maschio - Male plug		0,010
L 06 00 192	C	Preso semplice femmina - Female socket		0,030
L 06 15 191	D	Preso con spina - Socket with plug		0,050
L 06 00 030	E	Preso a 12V. in ottone cromato-12V. Socket in chromed brass		0,040



Completo presa e accendisigari

Realizzato in plastica. Preso con cappuccio in gomma.

Socket and cigarette lighter plug

Manufactured in plastic. Socket with rubber cap.

Spinotto universale per presa accendisigari

Con fusibile 8A.

Double use 12V. deck cable connector

Fuse 8A.

Spinotto per prese 12V.

12V. Standard plug

Articolo - Item	Volts	€/Kit	kg.	Articolo - Item	Volts	€/pc.	kg.	Articolo - Item	€/pc.	kg.
L 06 01 338	12		0,070	L 06 12 008	12		0,020	Z 20 81 012		0,010



Preso di corrente accendisigari completa di carenatura e guarnizioni

Montaggio verticale e orizzontale.

Cigarette lighter connector

Vertical and horizontal mounting.

Accendisigari e luce di cortesia

Fabbricato in acciaio e provvisto di luce orientabile di cortesia e di accendisigari.

Dashboard electric lighter

Manufactured in steel. With adjustable light and coiled cord.

Prese multiple con attacco accendisigari

In policarbonato nero. Complete di cavo e spina.

Cigarette lighter connectors

Manufactured in black polycarbonate. With plug.

Articolo - Item	mm.	Volts	€/pc.	kg.	Articolo - Item	Modello	Volts	€/pc.	kg.
L 06 01 331	80 x 65 x 43	12		0,100	L 06 00 012	Preso accendisigari. Cigar. lighter plug	12		0,110

Articolo - Item	Tipo	Modello	Volts	€/pc.	kg.
L 06 01 333	A	Preso 3pla c/ spina Triple socket w/plug	12		0,130
L 06 00 244	B	Preso 4pla c/spina Quadruple socket w/ plug	12		0,190

**Ventilatore a parete 12V.**

Orientabile con cavo e presa accendisigari.
A due velocità.

Wall ventilator 12V.

Swinging model. With cable and cigarette lighter plug.
Double speed.

Articolo - Item	←→ cavo-cable mt.	Ø est.-ext. mm.	kg.	€/pc.
L 64 12 063	1,600	150	0,310	

**Ventilatore 12V.**

Orientabile con cavo e presa accendisigari.
Lunghezza cavo 200 cm.
Confezione singola.

Ventilator 12V.

Swinging model.
Supplied with cigar-lighter plug.
Cable length 200 cm.
Single packing.

Articolo - Article	Ø esterno - outer Ø mm.	€/pc.
L 64 00 601	180	

Supporti a parete per TV - Wall TV support

A



B

Supporti a parete TV LCD

Realizzati in alluminio.
Per schermi da 13" a 30".

Wall support for LCD TV

Suitable for displays from 13" up to 30".
Manufactured in aluminium.

Articolo - Item	Mod.	Tipo -Type	mm.	←→ Braccio-Arm mm.	kg.	€/pc.
H 10 01 396	A	1 snodo-junction	114 x 114 x 98	-	0,800	
H 10 03 396	B	3 snodi-junctions	116 x 152 x 81	390	1,250	*

Rilevatori fughe di gas - Gas detectors

Sensibile rilevatore per tutti i gas nocivi (GPL - monossido di carbonio - gas soporiferi).

Il **gas detector** è dotato di uscita per comando elettro-valvola di blocco, o ventola di evacuazione, oltre a 1 led di segnalazione di stato e uno di allarme o anomalia.

Utilizzo senza installazione.

Possibilità di fissaggio a parete.

In conformità alla normativa 89/336/EEC - 93/68/EEC.

Confezione in scatola singola.

12V.

► **Circuito a Microprocessore Taratura Automatica Elevata Sensibilità**

► **Microprocessor Circuit Automatic Calibration High Sensitivity**

Rilevatore gas - Gas detector

Thanks to its high sensitivity, it is capable of detecting in the air gas concentrations (LPG - carbon monoxide - soporific gas).
The **gas detector** is supplied with output for locking electrovalve control, or evacuation vent, 1 status indication led, 1 alert led.
Use without installation. Wall mounting available.
In accordance with rule 89/336/EEC - 93/68/EEC.
Single packing in box.

Articolo - Article	Dimensioni base Base size mm.	Spessore Thickness mm.	Tensione Voltage V. DC	Consumo modalità Stand-by Consumption in Stand-by mode mA	Consumo modalità Allarme Consumption in Alarm mode mA	Segnale acustico Acoustic signal db	Sensibilità Sensitivity ppmEEC	€/pc.
L 23 95 057	95 x 57	31	5 - 14	60	180	85	95	

«CO»



Il rilevatore **MTCO** è in grado di avvertire la **presenza nell'aria di monossido di carbonio (CO)**.

Versione da incasso o da parete con distanziale in dotazione. Completo di cornice. Colore grigio. Confezione in scatola singola.

MTCO detects the **gas concentration in time to prevent poisoning accidents**.

Built-in version or wall-fixing version. The kit includes frame and spacer for the wall fixing. Grey colour. Single packing in box.

Articolo - Article	Alimentazione - Power supply	mm.	€/pc.
L 23 28 002	12V.	60 x 60	

* Disponibile su richiesta - Available on request

Lampade portatili - Portable lamps



LED waterproof

**Proiettore portatile al led impermeabile**

Corpo in Abs e caoutchouc. Colore bianco-blue. Funzionamento a 3 batterie C (non incluse). 3 posizioni: intenso, standard, SOS. Provvisto di blocco pulsante per lasciare luce fissa.

LED projector waterproof

ABS body and rubber, function with 3 batteries (not included). 3 different functions: high fixed light, low fixed light, SOS signal. Provided with lock button and support.

Articolo - Item	Portata Visibility mt.	€/pc.	kg.
L 22 35 067	450		



LED waterproof

**Mini lampada subacquea impermeabile fino a 100 mt di profondità**

Fabbricata in policarbonato e gomma. Provvista di 1 led a 3 watt. Funzionamento con 4 batterie modello AA (non incluse).

Mini LED diving torch light - 100 mt diving

Made in polycarbonate and rubber. Function with 4 batteries AA (not included), 1 led x 3 watt

Articolo - Item	mm.	Lumens	Impermeabile fino a profondità mt.	€/pc.	kg.
L 22 00 323	∅ 50 x 160	150	100		

Diving 100mt.

waterproof

Torcia luminosa impermeabile

Fabbricata in plastica e rivestita in gomma. Torcia con autonomia superiore a 50 ore.

Waterproof torch light

Manufactured in plastic and covered with rubber. Duration > 50 hours.

Articolo - Item	Modello-Model	€/pc.	kg.
L 20 00 021	Impermeabile-Waterproof		0,190



waterproof

Torcia luminosa frontale**Head torch**

Articolo - Item	Batterie-Batteries	Led	€/pc.	kg.
L 20 01 649	1,5 x 3	1W.		0,320



made by TREM

Torcette luminose anfibia

Accensione ad avvitemento.

Torch lights

Floating, operated by unscrewing.

Articolo - Item	Modello - Model	€/pc.	kg.
L 19 77 002	Normale - Normal		0,200



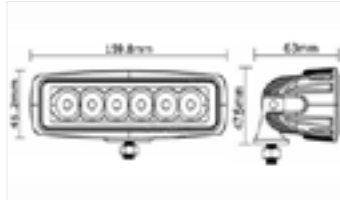

Proiettore impermeabile a led

Supporto in acciaio inox.
Fonte luminosa: 6 led x 3W
Tensione operativa: 10-30VDC
Carcassa Alu rettangolare bianco.
Temperatura colore: 6000K
Potenza: 18 Watt
Lumens 1200



High power waterproof Led spotlight

Stainless steel holder.
Light source: 6 led x 3W
Operating voltage: 10-30VDC
White rectangular alu cover.
Colour temperature: 6000K
Power: 18 Watt
Lumens 1200

Articolo - Item	mm.	€/pc.	kg.
L 22 50 160	H.45 x L.160 x P.50		0,180

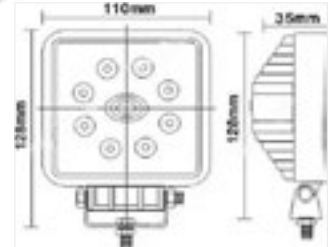

Proiettore impermeabile a led

Fonte luminosa: 8 led x 3W.
Tensione operativa: 10-30VDC
Carcassa Alu quadrato bianco.
Temperatura colore: 6000K
Potenza: 24 Watt
Lumens 1600



High power waterproof Led spotlight

Light source: 8 led x 3W.
Operating voltage: 10-30VDC
White square alu cover.
Colour temperature: 6000K.
Power: 24 Watt
Lumens 1600

Articolo - Item	mm.	€/pc.	kg.
L 22 30 105	H.125 x L.105 x P.30		0,210

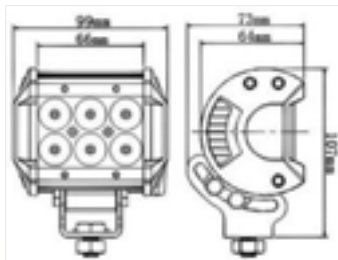

Proiettore impermeabile a led

Fonte luminosa: 6 led x 3W liuce intensa
Tensione operativa: 9-30VDC
Carcassa Alu rettangolare bianco.
Temperatura colore: 6000K
Potenza: 18 Watt
Lumens 1080



Waterproof Led spotlight

Light source: 6 led x 3W high intensity CREE LEDs
Operating voltage: 9-30V DC
White rectangular diecast alu housing.
Colour temperature: 6000K.
Power: 18 Watt
Lumens 1080

Articolo - Item	mm.	€/pc.	kg.
L 22 73 099	H.107 x L.99 x P.73		0,550

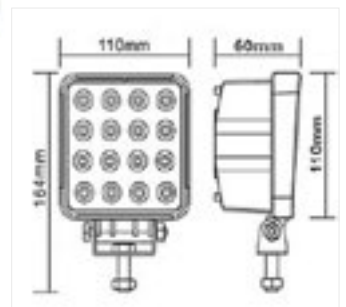

Proiettore impermeabile a led

Fonte luminosa: 16 led x 3W
Tensione operativa: 10-30VDC
Carcassa Alu quadrato bianco.
Temperatura colore: 6000K
Potenza: 48 Watt
Lumens 2880



High power waterproof Led spotlight

Light source: 16 led x 3W.
Operating voltage: 10-30VDC
White square alu cover.
Colour temperature: 6000K.
Power: 48 Watt
Lumens 2880

Articolo - Item	mm.	€/pc.	kg.
L 22 16 110	H.164 x L.110 x P.60		0,550

Pulizia e manutenzione

Cleaning and maintenance



Mini lavatrice compatta
1,8 kg. - 230 V. - 50 Hz.

Modello ideale per nautica.
Cestello in polipropilene
trasparente.



Mini washing machine
1,8 kg. - 230 V. - 50 Hz.

Suitable for boating.
Drum in transparent polypropylene.



CE



Articolo - Item	mm.	Consumo Consumption	kg.	€/pc.
Z 08 91 913	365 x 344 x 476	10 W.	5,000	

Tubi acqua - Water hoses



**Tubo alta pressione acqua
potabile**

**High pressure hose for drinking
water**

Articolo - Item	mt.	€/pc.	kg.
N 01 11 838	8,00		0,970



**Arrotolatore in ABS completo di
tubo in PVC e accessori**

**Hose on reel in ABS with PVC
tube and accessories**

Articolo - Item	mt.	€/pc.	kg.
N 01 15 305	15		



**Adattatore di collegamento per
rubinetti tondi con diametro
15-25mm**
Senza filetto.

**Connection adapter for round
taps with
15-25mm diameter**
Without thread.

Articolo - Item	€/pc.	kg.
N 01 65 406		



Kit composto da - Kit composed by:

- Tubo PVC 12x17mm con rete di rinforzo - PVC hose 12x17mm with reinforced net
- Resistente ad alta pressione - High pressure resistant
- Pistola a getto regolabile - Adjustable spray water gun
- 2 Raccordi a scatto - 2 Quick snap connections
- Raccordi di riduzione - Reducer connections



Impugnatura per cavi e tubi

Cable Wraptor

Articolo - Item	↑ mm.	€/pc.	kg.
Z 20 02 090	180 x 90		0,080



Kit tubo lavaggio barca

Composto da tubo da mm 12x17 in pvc bianco con rete di rinforzo interna in poliestere, tipo alta pressione resistente fino a 15 BAR + pistola a getto regolabile con innesto a scatto + 3 raccordi a scatto per rubinetto a terra.

Hose kit for boat cleaning

Composed by hose mm 12x17 in white pvc with reinforced internal polyester net, high pressure type, resistant up to 15 BAR + adjustable spray water gun with quick snap connection + 3 fitting connections for flat tap.

Articolo - Item	mt.	Raccordi Fittings	€/Kit	kg.
N 01 02 015	15	1/2-3/4-1"		1,500
N 01 25 025	25			2,500



Tubo in PVC retinato

Flessibile atossico con doppio rinforzo tessile magliato (TRICOT) ad alta resistenza antitorione. Resistente agli agenti atmosferici. Pressione di esercizio 15 bar. Ideale per il lavaggio del camper o usi vari.

Screened PVC pipe

High resistant PVC pipe with double screened reinforcement (TRICOT). High resistance to atmospheric agents. Max working pressure 15 bar, excellent for caravan cleaning.

Articolo - Item	mt.	Ø interno inner	Ø esterno outer	€/pc.	kg.
N 01 12 018	50	12	17		
N 01 15 021	50	15	21		



Kit pistola e raccordi per tubo 12x17mm

Kit water gun and hose fittings 12x17mm

Articolo - Item	Raccordi Fittings	€/pc.	kg.
R 09 12 018	1/2-3/4-1"		



Arrotolatore per cavi e tubi con maniglia per il trasporto

Cable and hose wraptor with handle

Articolo - Item	↑ mm.	€/pc.	kg.
Z 20 01 090	378 x 168 x 67		





Kit composto da spazzolone con asta telescopica

Set pulizia composto da asta in alluminio telescopica e spazzolone con setola morbida.
Predisposto per innesto tubo acqua sul manico.

Washing kit with boat brush extra and telescopic pole

Hollow anodised aluminium telescopic pole.
Brush with soft bristles. With waterfeed possibility.

Articolo - Item	Ø mm.	←→ cm.	Modello - Model		€/Kit	kg.
R 38 02 166	19 - 22,6	100 ≈ 180	Kit con spazzola setole morbide Kit with soft bristle brush	4		1,500



Kit composto da spazzolone con asta telescopica e dosasapone

Washing kit with boat brush ,telescopic pole and soap dispenser

Articolo - Item	Ø mm.	←→ cm.	Modello - Model		€/Kit	kg.
R 38 19 400	19 - 22,6	100 ≈ 180	Kit con spazzola a setole morbide con raccogliacqua e dosasapone Kit with soft bristle brush, water-case and soap-dispenser	4		



Attacco rinforzato in alluminio
Alu reinforced connection



Kit composto da spazzolone con asta telescopica

Washing kit with boat brush ,telescopic pole

Articolo - Item	Ø mm.	←→ cm.	Modello - Model		€/Kit	kg.
R 38 32 440	32 - 25	140 ≈ 250	Kit con spazzola a setole morbide con gomma antiurto, attacco alu fuso Kit with soft bristle brush, shock proof rubber, melted alu joint	12		1,100



Kit 4 pezzi composto da mezzo marinaio, spazzolone e frattazzo in cotone

Tutti gli elementi sono intercambiabili e facilmente inseribili sul tubo di alluminio telescopico.

Washing kit 4 pieces composed of: boat hook - cotton brush - scrubbing brush - telescopic pole

All items are easily interchangeable and can be fitted onto the telescopic aluminium pole.

Confezione self-service Self-service packing



Articolo - Item	←→ cm.	Mod.	€/kit	kg.
R 38 03 381	da 120 a 215	«Trem-Friend 4»		3,800



**Panno pulizia in PVA****PVA cleaning cloth**

Articolo - Item	↳ cm.	Colore - Colour		€/pc.	 kg.
N 58 00 066	66 x 43	Giallo - Yellow	50		0,160
N 58 89 066	66 x 43	Rosa - Pink	50		0,160
N 58 85 066	66 x 43	Verde acqua - Light green	50		0,160
N 58 75 066	66 x 43	Azzurro - Light blue	50		0,160

**Guanto in microfibra****Microfibre cloth**

Fabbricato con centinaia di morbide microfibre. Ideale per pulire grandi superfici in poco tempo.

Mde with hundreds of soft microfibres. Ideal for cleaning big surfaces in short time.

Articolo - Item	Colore - Colour		€/pc.	 kg.
R 38 20 066	Arancio - Orange	60		0,130

**Spugna ad altissimo assorbimento e a lunga durata****High absorbtion sponge, huge resistance**

Articolo - Item	↳ mm.	Colore - Colour	€/pc.	 kg.
N 58 80 210	210 x 110 x 80 H.	Giallo - Yellow		0,160

**Porta sacchetti della spazzatura****Garbage holder**

Questo portarifiuti si fissa a parete in maniera semplice e permanente utilizzando le viti o il biadesivo. Compatibile con sacchetti standard.

Easy wall mounting by use of screws or double-sided tape. Suitable for standard garbage bags.

Articolo - Item	↳ cm.	Colore - Colour	€/pc.	 kg.
Z 18 14 031	31 x 14	<input type="checkbox"/> Bianco-White		0,210

**Spazzolino WC****Toilet cleaning brush**

Provvisto di custodia. Montaggio a parete con viti o bioadesivo.

With case. Wall mounting by screws or double-sided tape.

Articolo - Item	↳ cm.	€/pc.	 kg.
Z 18 08 026	26 x 8		0,060

Portarifiuti

Realizzato in polipropilene.
Confezione singola.

Garbage holder

Made in polypropylene.
Single packing.

Articolo - Article	↑ mm.	Volume lt.	Colore - Colour	€/pc.
Z 18 02 510	60 x 130	4,50	Bianco - White	



Paper light (carta igienica speciale)

Carta igienica a due veli.
Si disintegra velocemente senza intasare i serbatoi di scarico.
Confezione in sacchetto da 4 rotoli.

Paper light (special toilet paper)

2 ply soft tissue. Quick dissolution to prevent any tamping of the exhaust tanks.
Packing in polybag of 4 reels.

Articolo - Article	📦 gr.	€/Confezione - Packing
Z 18 00 100	100	



Liquido concentrato per W.C. Chimici «Fluisan» formaldeide al 5 % come da normative

Liquido concentrato sterilizzante e deodorante per W.C.
Confezione in fustino di plastica.

Concentrated liquid for chemical toilets «Fluisan» formaldehyde 5% according to rules

It allows to sterilize and eliminates odours in the WC.
Packing in plastic can.

Articolo - Article	Contenuto Content lt.	Quantità per cartone Quantity per carton	📦 gr.	€/pc.
Z 18 01 000	1	20 fustini - 20 cans	1100	
Z 18 04 000	5	4 fustini - 4 cans	5200	



Porta-carta igienica colore bianco

Completo di viti e biadesivo per l'applicazione.
Confezione singola.

Toilet paper holder White colour

Supplied with fixing screws and double-sided tape.
Single packing.

Articolo - Article	↑ mm.	€/pc.
Z 18 13 150	130 x 150	



WC chimico mod. «Portatile»

Completo di vasca di recupero.
Fabbricato in materia plastica

Chemical toilet

With tank.
In plastic material.

Articolo - Item	Mod.	↑ mm.	Lt.	📦 kg.	€/pc.
Z 18 00 436	A	H 415 x L 410 x P 355	20	6,070	
Z 18 66 027	B	H 324 x L 436 x P 365	15	4,300	



**Secchio pieghevole**

Fabbricato in robusto nylon. Maniglia in acciaio inox. Completo di custodia.

Folding bucket

Manufactured in nylon. Handle in stainless steel. Supplied with case.

Articolo - Item	Ø esterno - outer mm.	mm.	€/pc.	kg.
P 00 24 225	240	225		0,460

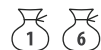
**Secchio nautico con manici inox a occhiello**

Fabbricato in materiale termoplastico con manico per aggancio sopra.

Bucket for nautical purposes with stainless steel grommet handle

Made of strong thermoplastic material with handle for rope hooking.

Articolo - Item	Litri - Litres	mm.	€/pc.	kg.
P 00 23 000	6	Ø 230 x H 230		0,400
P 00 25 000	9	Ø 250 x H 250		0,500
P 00 33 000	12	Ø 280 x H 330		0,800

**Secchio in silicone pieghevole**

Maniglia in plastica.

Folding silicon bucket

With plastic handle.

Articolo - Item	Portata lt.	↑ aperto mm.	↓ chiuso mm.	€/pc.	kg.
P 00 32 000	10	Ø 320 x 240 H.	Ø 320 x 50 H.		0,460

**Secchio nautico affondante in gomma****Submersible rubber nautical bucket**

Articolo - Item	Litri - Litres	€/pc.	kg.
P 00 10 000	9		1,500

L'UNICO SECCHIO CHE SI RIEMPIE CON UN SOLO LANCIO!
THE SOLE BUCKET THAT YOU FILL WITH A ONLY LAUNCHING!





Spazzola a mano

A setole dure con comoda impugnatura.

Hand brush

Stiff bristle with comfortable handle.

Articolo - Item	€/pc.	kg.
N 58 00 131		0,290



Spazzola speciale per la pulizia della carena

Spazzola con impugnatura. Ideale per togliere le incrostazioni dalla carena dell'imbarcazione.

Boat brush for hull cleaning

Suitable for boat cleaning.

Articolo - Item	mm.	Mod.	€/pc.	kg.
N 58 90 150	150 x 90	Duro - Stiff		0,050
N 58 90 152	150 x 90	Morbido - Soft		



Spazzole a mano a setole dure con impugnatura

Hand brushes stiff bristle with handle

Articolo - Item	Mod.	kg.	€/pc.
N 58 51 502	A	6	
N 58 50 800	B	12	



Spatola in silicone per pulizia vetri

Sylicon water and window wiper

Articolo - Item	Mod.	€/pc.	kg.
N 58 00 211	A - Snodato con impugnatura Articulated with handle		0,250



Cassetta attrezzi professionale

Professional tool box

Valigia in materiale plastico antiurto. Utensili fabbricati in cromo vanadium. Contiene 58 utensili.

Tool box made in plastic anti-shock material. Tools made in chromo vanadium.

Composta da:

Box includes:

- 20pcs punte per cacciavite
- 1pc martello
- 1pc cutter
- 2pcs ø6x100 cacciaviti
- 1pc 6" pinza a becco lungo
- 4pcs cacciaviti di precisione
- 5pcs chiavi esagonali
- 1pc adattatore flessibile
- 8pcs chiavi inglesi
- 9pcs adattatori esagonali
- 1pc pinza 6"
- 1pc metro
- 1pc livella
- 1pc nastro isolante
- 1pc cacciavite tester digitale
- 1pc metro 3 metri

- 20pcs screwdriver bits
- 1pc claw hammer
- 1pc utility knife
- 2pcs ø6x100 screwdrivers
- 1pc 6" long nose plier
- 4pcs precision screwdrivers
- 5pcs hex wrenches
- 1pc universal flexible shaft
- 8pcs combination spanners
- 9pcs sockets
- 1pc 6" combination plier
- 1pc extension rod
- 1pc spirit level
- 1pc insulating tape
- 1pc digital test pencil
- 1pc 3M measuring tape

Articolo - Item	cm.	€/box	kg.
D 10 42 033	42 x 9 x 33		



B



A



**Lubrificante multi funzionale WD 40**

Idrorepellente, anticorrosivo, lubrificante sbloccante e detergente.
Confezione in scatola.

Multi function WD 40 lubricating

Water-repellent, anti-corrosive, unblocking lubricating and detergent.
Packing in box.

Articolo - Article	Contenuto - Content gr.	Pezzi - Pcs.	€/pc.
E 40 00 200	200	36	
E 40 00 400	400	24	

Sikaflex - 221**Sigillante adesivo monocoprente poliuretano****Campi di applicazione:**

Adatto ad un'ampia varietà di substrati, idoneo alla realizzazione di sigillature permanenti elastiche e ad alto potere adesivo. Ideale per legno, metallo e materie plastiche.

Vantaggi:

- monocoprente
- elastico
- resistente all'invecchiamento
- non corrosivo
- carteggiabile
- sovraverniciabile
- inodore

Confezione da 12 pezzi.

One-component polyurethane adhesive sealant**Areas of application:**

Suitable substrate materials are timber, metals, metal primers and paint coatings (two-part systems), ceramic materials and plastics.

Product benefits:

- one-part formulation
- elastic
- resistant to ageing and weathering
- non-corrosive
- can be sanded
- can be overpainted
- low odour

Packing of 12 pcs.

Articolo - Article	Modello - Model	Colore - Colour	€/pc.
E 37 74 221	cartuccia - cartridge 310 ml.	Bianco - White	

Sikaflex - 252**Adesivo elastico ad alta resistenza****Campi di applicazione:**

Sikaflex®.252 è ideale per giunti strutturali soggetti a stress dinamici e per substrati quali: legno, metalli, alluminio (anche anodizzato) e lamiera.

Vantaggi:

- monocoprente
- elastico sovraverniciabile
- non corrosivo
- smorza le vibrazioni
- carteggiabile

Confezione da 12 pezzi.

High tenacity structural adhesive**Areas of application:**

Suitable for structural joints that will be subjected to dynamic stresses. Substrate materials: timber, metals, aluminium, sheet steel.

Product benefits:

- one-part formulation
- elastic can be overpainted
- non-corrosive
- capable of withstanding high dynamic stresses
- can be sanded

Packing of 12 pcs.

Articolo - Article	Modello - Model	Colore - Colour	€/pc.
E 37 74 252	cartuccia - cartridge 310 ml.	Bianco - White	

Sikaflex - 521 UV**Sigillante monocoprente resistente ai raggi UV****Campi di applicazione:**

Sigillature esterne per metalli, porte, finestre, bagni.

Si incolla bene ad un'ampia varietà di substrati senza necessità di primer.

Vantaggi:

- non ingiallisce
- lunga durata nel tempo
- non ammuffisce
- senza solventi
- non corrosivo - sovraverniciabile

Confezione da 12 pezzi.

Excellent adherent, weathering and UV resistant sealant**Areas of application:**

Suitable for making permanent elastic seals of high adhesive strength.

Substrate materials are timber, metals, metal primers and paint coatings, ceramic materials and plastics.

Product benefits:

- one-part formulation
- resistant to UV radiation
- can be overpainted
- non-corrosive
- PVC-free

Packing of 12 pcs.

Articolo - Article	Modello - Model	Colore - Colour	€/pc.
E 37 74 521	cartuccia - cartridge 310 ml.	Bianco - White	



Nastro anti-sfregamento		Anti-rubbing adhesive tape		
Articolo - Item	mm. x mt.	kg.	€/pc.	
D 16 05 003	50 x 3	0,080		
D 16 05 002	50 x 2	0,080		



Nastro in Pvc autoamalgamante		Pvc self-adhesive tape		
Articolo - Item	mm.	mt.	kg.	€/pc.
E 35 19 080	19	5,0	0,100	

Indicato per il rivestimento di parti elettriche, finiture di impiombature, bloccaggio di tenditori ed arridatoi, ecc. Colore nero.

Suitable for the coating of electrical parts. Black colour.



Nastro adesivo in Pvc espanso morbido per oblò, passi uomo, finestrini, ecc.		Pvc foamed adhesive tape for portholes, hatches, doors			
Articolo - Item	mm.	Spessore Thickness mm.	mt.	kg.	€/pc.
E 35 15 095	19	3	3,0	0,100	

Nastro in espanso morbido a cellule chiuse autoadesivo, indicato per ricreare la tenuta stagna negli oblò, passi uomo, finestrini, ecc.

Suitable for the good tight-seal of the doors.



Adesivo resistente ai raggi UV mod. «Duck Tape»		UV resistant adhesive tape mod. «Duck Tape»		
Articolo - Item	Colore - Colour	mm.	kg.	€/pc.
E 46 74 050	Bianco-White	50 mm. x 5 mt.	0,140	
E 46 79 050	Grigio-Grey	50 mm. x 5 mt.	0,140	

Nastro in tessuto adesivo ad alta tenacità, ideale per riparare tessuti e vele. Modello impermeabile resistente ai raggi UV.

High tenacity adhesive tape. Suitable for fabric and sail repair. Waterproof and UV resistant.



Adesivo in fibra di vetro bicomponente		Fibreglass adhesive tape		
Articolo - Item	Colore - Colour	mm.	kg.	€/pc.
E 35 77 150	Trasparente-Transparent	100 x 150	0,050	
E 35 82 300	Trasparente-Transparent	100 x 300	0,100	

Ideale per riparazione di canoe e kayaks. Fibra di vetro da un lato e dall'altro un'applicazione di resina epossidica. Si applica da 5 a 15 minuti.

Suitable for canoe and kayak repair. Application time 5/15 minutes.



Nastro autoadesivo in Pvc espanso morbido per sigillare fessure di porte e finestre		Self adhesive tape made of soft Pvc suitable to seal doors and windows		
Articolo - Article	Altezza Height mm.	Spessore Thickness mm.	€/Rotolo - Reel	
E 35 15 095	15	3		

Confezione in rotolo da 6 metri.

Packing in reel of 6 mt.

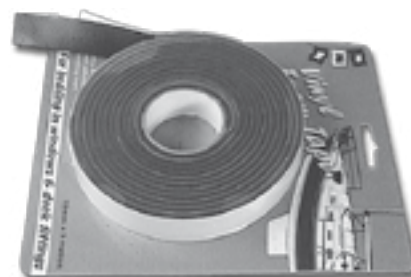

Camping

**Ghirba pieghevole con rubinetto**

Fabbricata in polietilene alimentare. Provvista di rubinetto e manico. Pieghevole e di minimo ingombro.
Confezione in scatola da 10 pezzi.

Folding water tank with tap

Made of alimentary polyethylene. With tap and handle. Folding to spare room during transport.
Packing in box of 10 pcs.

Articolo - Article	Capacità - Capacity lt.	€/pc.
N 01 20 002	20	

Doccia solare in speciale pvc per ottenere l'acqua calda

Completa di tubo e doccia. Minimo ingombro e molto leggera. Confezione singola.

Solar sunshower made of pvc to get hot water

With shower and tube. Small size and light. Single packing.

Articolo - Article	Capacità - Capacity lt.	Modello - Model	€/pc.
N 01 20 300	18	Con tappo inferiore With lower plug	

**Nuova serie taniche con rubinetto per acqua potabile**

Munite di rubinetto con filetto applicato alla base. Confezione singola.

New water tank with tap for fresh water

With threaded tap. Single packing.

Articolo - Article	Capacità - Capacity lt.	€/pc.
N 01 10 125	10	
N 01 20 125	20	

**Portabicchieri a molla (6 pezzi)**

Ideale per bicchieri pic-nic. In filo acciaio plastificato. Confezione SELF-SERVICE da 6 pezzi.

Spring-type glass-holder (6 pcs.)

Suitable for pic-nic glasses. In plastic-covered steel wire. SELF-SERVICE packing of 6 pcs.

Articolo - Article	Per bicchieri - For glasses Ø mm.	gr.	€/Conf. - Packing
D 17 64 090	64	110	

**Amaca porta oggetti**

Tessuta con filati di fibra sintetica. Munita di tenditori in corda all'estremità. Confezione singola e in sacchetto da 10 pezzi.

Stowage hammock

Woven with synthetic fibre braid. Supplied with fastening rope. Single packing and in polybag of 10 pcs.

Articolo - Article	Lunghezza - Length cm.	gr.	€/pc.
Z 00 00 390	50	390	

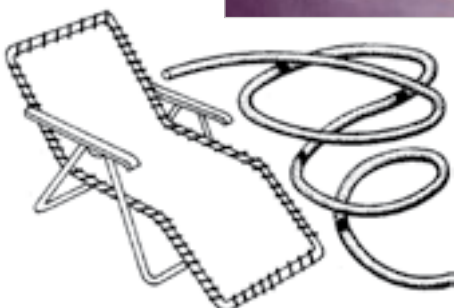
**Corda elastica per lettini e seggiole 10,50 mt.**

Confezione in buste da 10,50 mt. e in sacchetto da 10 buste.

Elastic cord for bunk and chairs 10,50 mt.

Packing in bag of 10,50 mt. and in polybag of 10 bags.

Articolo - Article	Ø mm.	gr.	€/Set 10,5 mt.
Z 39 06 105	6	270	



Binocolo 10 x 50

Rivestito in gomma colore nero. Completo di tracolla e custodia. Confezione singola.

Binocular 10 x 50

Black rubber armaring. With currying case and strips. Single packing.

Articolo - Article	€/pc.
L 29 10 050	



Bussola di rilevamento «Standard»

Provista di lente di ingrandimento con doppia scala. Bussola stabilissima e con lettura molto chiara. Confezione singola e in scatola da 12 pezzi.

Handbearing compass «Standard»

Equipped with magnification lens with double dial. Very firm compass with user-friendly reading. Single packing and in box of 12 pcs.

Articolo - Article	Ø Quadrante - Dial mm.	gr.	€/pc.
L 25 35 135	45	80	



Bussola di rilevamento con scalimetro

Con scalimetro laterale, provvista di lente di ingrandimento con lettura notturna molto chiara. Doppia scala in gradi e rombi. Confezione singola e in scatola da 12 pezzi.

Handbearing compass with dial

With side dial and magnification lens for night reading. Double dial in grades and rhombes. Single packing and in box of 12 pcs.

Articolo - Article	Ø Quadrante - Dial mm.	gr.	€/pc.
L 25 03 017	45	113	

Pompe - Pumps



>Gonfia - Sgonfia Gonfiatore elettrico a 12V.

Fabbricato in fibra di nylon. Provvisto di riduzioni e di attacco accendisigari. Confezione singola.

>Inflating - Deflating Electric inflator 12V.

Manufactured in nylon fiber. Supplied with nozzle fittings. Cigarette lighter plug. Single packing.

Articolo - Article	Modello - Model	Peso - Weight gr.	€/pc.
Z 06 18 544	Universale - Universal	500	



Gonfiatore a pedale

Fabbricato in materia plastica resistente. Il gonfiatore è corredato di tubo flessibile e raccordi universali. Confezione da 6 pezzi.

Foot inflator

Manufactured in strong and resistant plastic material. Equipped with flexible pipe and universal nozzle fittings. Packing in box of 6 pcs.

Articolo - Article	Modello - Model	Portata - Load lt.	Peso - Weight gr.	€/pc.
Z 06 00 130	Grande - Big	5	1300	

Pompa a doppio effetto

Pompa a doppio effetto da 3 a 4 litri. Completa di tubo e raccordi universali. Confezione singola.

Double action stirrup pump

Double action pump: 3/6 litres. Supplied with hose and fittings. Single packing.

Articolo - Article	Litri - Litres	Lt./min.	€/pc.
Z 06 04 200	4	200	





Pompa a mano

Hand pump

Articolo - Item	Modello Model	€/pc.	kg.
Z 06 20 050	A - Bravo 4 alu red		
Z 06 20 040	B - Bravo 4		



Pompa elettrica Turbo Max

Portata 1000 lt/min. Gonfia/sgonfia.
12 volts. 540/720 watts. Pressione 250 mbar (3,6PSI)

Electrical pump Turbo Max

Capacity 1000 lt/min. Inflate/deflate system. 12 volts. 540/720 watts. Pressure 250 mbar (3,6PSI)

Articolo - Item	mm.	Modello Model	€/pc.	kg.
Z 06 30 022	310 x 180 x 190	A - Bravo Turbo Max 12V.		
Z 06 30 021	330 x 210 x 230	B - Bravo Turbo Max kit 12V.		
Z 06 21 015	-	C - Tubo Ø 25 bobina 25mt. Pipe Ø 25 reel 25mt.		



Pompa a mano

Gonfia/sgonfia + manometro.
Doppio polmone 2 x 2,5 litri max.

Hand pump

Inflate/deflate system + manometer. Double chamber 2 x 2,5 lt max.

Articolo - Item	PSI	Modello Model	€/pc.	kg.
Z 06 20 700	14,5 max	Bravo 110		



Pompa a pedale

Max 300 mbar.

Foot pump

Max 300 mbar.

Articolo - Item	mm.	Modello Model	€/pc.	kg.
Z 06 70 003	-	A - Bravo 3		
Z 06 70 005	280 x 200 x 60	B - Bravo 5		



Pompa a mano

Pressione max 600mbar (8,7PSI).

Hand pump

Pressure max 600mbar (8,7PSI).

Articolo - Item	mm.	Modello Model	€/pc.	kg.
Z 06 20 006	210 x 120 x 470	Bravo 6		
Z 06 20 007	210 x 120 x 470	Bravo 6Manometer		



Pompa elettrica

Pressione 1000 mbar (14,5PSI).
Consumo 20A. Portata 160lt/min.
12 volts. 240 watts.

Electrical pump

Pressure 1000 mbar (14,5PSI).
Consumption 20A. Capacity
160lt/min. 12 volts. 240 watts.

Articolo - Item	↳ mm.	Modello Model	Tipo	€/pc.	kg.
Z 06 30 037	205x100x130	A - BP 12	Gonfia-Inflates		
Z 06 30 038	280x100x60	B - BP12 Manometer	Gonfia/Sgonfia Inflate/Deflate		



Pompa elettrica

Pressione 40 mbar (0,55PSI).
Consumo 4A. Portata 800lt/min.
12 volts. 48 watts.

Electrical pump

Pressure 40 mbar (0,55PSI).
Consumption 4A. Capacity
800lt/min.
12 volts. 48 watts.

Articolo - Item	PSI	↳ mm.	Modello Model	€/pc.	kg.
Z 06 30 004	0,55	∅ 120 x H.130	A - MB 5012 A		
Z 06 30 008	0,55	∅ 120 x H.130	B - MB 8010 A		



Pompa elettrica

Portata: Base 1200 lt/min.
Con booster 2000lt/min.
Pressione: Base 2,0 PSI
Con booster 5,8 PSI
Watts: Base 1000
Con booster 2000
Gonfia/sgonfia.
220volts.

Electrical pump

Capacity: standard 1200 lt/min.
with booster 2000lt/
min.
Pressione: standard 2,0 PSI
with booster 5,8 PSI
Watts: standard 1000
with booster 2000
Inflate/deflate system.
220volts.

Articolo - Item	↳ mm.	Modello Model	€/pc.	kg.
Z 06 30 200	320 x 170 x 260	Bravo 230/2000		



Tappo e valvola di ricambio per battelli mod. Standard

Spare plug and valve for boats mod. Standard

Articolo - Item	Modello Model	€/pc.	kg.
Z 06 02 700	Bravo 2001		



Pompa elettrica

Pressione 15000 mbar (22PSI).
Consumo 9A. Portata 125lt/min.
12 volts. 108 watts.

Electrical pump

Pressure 15000 mbar (22PSI).
Consumption 9A. Capacity
125lt/min.
12 volts. 108 watts.

Articolo - Item	↳ mm.	Modello Model	€/pc.	kg.
Z 06 30 700	540 x 340 x 220	Bravo 20		



> Serie 7 pz. componibili
> Series 7 pcs. modular



made by 



Serie aste di sostegno in fibra di vetroresina per tende ad igloo

Fabbricate in vetroresina. Elementi uniti da corda elastica interna. Leggerissime e di sezione tonda. Ideali per sostenere le tende da trekking. Confezione in busta da una serie di 7 aste.

Rod support for igloo tents

Manufactured in plastic reinforced by fiber glass. Very strong and flexible. Elastic cord inside. Very light. Suitable for trekking tents. Packing in bag of 1 series with 7 pcs.

Articolo - Article	Ø mm.	Lunghezza Length mm.	€/7 aste per confezione 7 poles for pack.
H 24 08 007	8	4200	
H 24 10 007	10	4550	

Bobinette corda elastica per aste igloo

Indicata sia per le aste in vetroresina, sia per il tipo in alluminio. Fabbricata in filato di poliestere colore bianco e lattice di gomma. Confezione in bobine.

Elastic rope for igloo tents

Suitable for fiber glass and aluminium poles. Manufactured in white polyester and rubber latex. Packing in reels.

Articolo - Article	Ø mm.	Confezione Packing mt.	€/Bobina Reel 20 mt.
C 10 25 020	2,5	20	

Fascette stringitubo per paletti

Praticando un foro nel tubo dei paletti, serve per rendere regolabile la paleria delle tende. Confezione SELF-SERVICE da 6 pezzi e in scatola da 10 confezioni.

Adjustable clips for tent poles

It allows to adjust the poles. SELF-SERVICE packing of 6 pcs. and in box of 10 packs.

Articolo - Article	Per pali - For poles Ø mm.	Conf. - Packing gr.	€/Set 6 pz. - pcs.
H 11 20 250	20 - 23	130	

Molla con noddolino per paletti

Confezione in buste da 100 pezzi.

Spring for tent poles

Packing in bag of 100 pcs.

Articolo - Article	Ø gr.	€/pc.	€/box
H 11 00 012	12		

Clips con asola per paletti tenda

Fabbricata in materiale plastico bianco. Confezione in busta da 100 pezzi.

Clips with eyelet for tent poles

Manufactured in white plastic material. Packing in bag of 100 pcs.

Articolo - Article	Ø esterno pali - Ø ext. poles mm.	Ø gr.	€/pc.	€/box
H 11 00 055	20 - 23	3		

Base con punta per paletti tenda

Fabbricata in materiale plastico. Adatta per montaggio interno. Confezione in busta da 100 pezzi.

Ground plate with bit for tent poles

Manufactured in plastic. Suitable for inner mounting. Packing in bag of 100 pcs.

Articolo - Article	Per tubi interno - For pipes int. Ø mm.	Ø gr.	€/pc.	€/box
H 24 22 060	18	10		

Tappi in plastica con puntalino in acciaio

Puntale lunghezza 6 cm. Indicati per montaggio all'interno dei paletti. Confezione in sacchetto da 50 pezzi.

Plastic cap with steel bit

Bit length 6 cm. Suitable for mounting inside the poles. Packing in bag of 50 pcs.

Articolo - Article	A - Ø mm. Interno - Internal	€/pc.	€/box
H 24 16 000	14		
H 24 18 000	16		
H 24 22 000	20		

► **Serie lega leggera**
 ► **Light alloy series**

Serie aste di colmo telescopiche in alluminio per sostegno tetto verande

Fabbricate in tre pezzi in una speciale lega di alluminio. Complete di fascetta stringitubo per la regolazione e di clips all'estremità per l'applicazione.
Tube esterno ø 20 mm.
 Confezione in busta da una serie e in scatola da 6 serie.

Set of ridge poles, telescopic made of aluminium, for roof tent support purpose

Made of special aluminium alloy. Three elements, supplied with locking collars and connecting clips.
External pipe ø 20 mm.
 Packing: bag of 1 set and in box of 6 sets.

Articolo - Article	Regolabile Adjustable cm.	Numero pz. Number of pcs.	€/Set 3 pz.- pcs.
H 23 03 170	120 - 170	3	

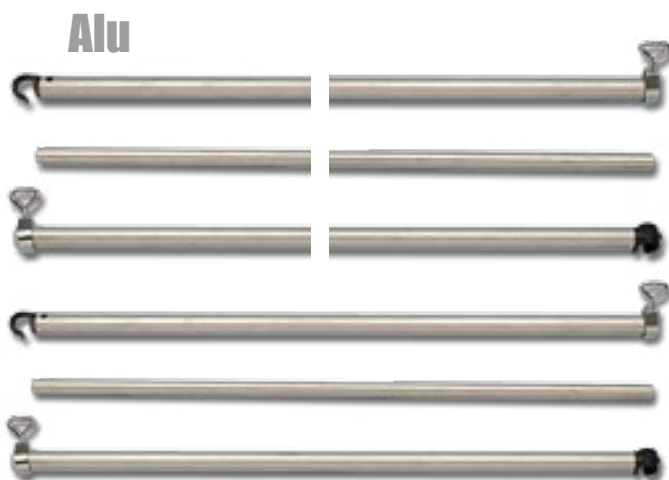

Serie paletti veranda componibili a 3 elementi in lega leggera

Composta di tre elementi
 1 Elemento base + 1 Elemento intermedio + 1 Elemento con puntale.
 Fabbricata in lega leggera di alluminio.
Tube esterno ø 20 mm.
 Confezione in busta da una serie di 3 pezzi e in scatola da 6 serie.

Set of 3 modular elements of light alloy poles

Set with:
 1 Basic element + 1 intermediate + 1 element with point.
 Manufactured in light aluminium alloy.

External pipe ø 20 mm.
 Packing: bag of 1 set with 3 pcs. and in box of 6 sets.

Articolo - Article	Regolabile Adjustable cm.	Numero pz. Number of pcs.	€/Set 3 pz.- pcs.
H 20 01 210	180	3	



Serie paletti veranda telescopici a 3 elementi in lega leggera

Fabbricati in una speciale lega di alluminio e completi di fascetta stringitubo per la regolazione.
Tube esterno ø 20 mm.
 Confezione in busta da una serie e in scatola da 6 serie.

Set of telescopic tent poles of 3 elements made of light alloy

Manufactured in light aluminium alloy. Supplied with locking collars for adjusting.
External pipe ø 20 mm.
 Packing: bag of 1 set and in box of 6 sets.

Articolo - Article	Regolabile Adjustable cm.	Numero pz. Number of pcs.	€/Set 3 pz.- pcs.
H 21 01 215	150 - 215	3	
H 21 01 250	180 - 250	3	



Serie aste di colmo telescopiche in lega leggera

Fabbricate in una speciale lega di alluminio e complete di fascetta stringitubo per la regolazione.
Tube esterno ø 20 mm.
 Confezione in busta da una serie e in scatola da 6 serie.

Set of ridge poles telescopic made of light alloy

Made of special aluminium alloy. Three elements, supplied with locking collars and connecting clips.
External pipe ø 20 mm.
 Packing: bag of 1 set and in box of 6 sets.

Articolo - Article	Regolabile Adjustable cm.	Numero pz. Number of pcs.	€/Set 3 pz.- pcs.
H 23 01 215	150 - 215	3	



**Picchetti mod. «Ercules»**

Fabbricati in lamiera di acciaio zincata e tropicalizzata 10/10 spessore. Provvisti di nervatura centrale e dentino che garantisce lunga durata e robustezza anche su terreni duri.
Confezione SELF-SERVICE da 6 pezzi.

Tent pegs mod. «Ercules»

Manufactured in zinc-coated sheet-metal.
Width 10/10.
With central rib.
Very strong and resistant.

SELF-SERVICE packing of 6 pcs.

Articolo - Article	Lunghezza - Length cm.	Conf. - Packing gr.	€/Set 6 pz. - pcs.
H 01 25 070	25	370	
H 01 30 090	30	390	

**Picchetti mod. «Export»**

Fabbricati in lamiera di acciaio zincata e tropicalizzata 10/10 spessore.
Provvisti di nervatura centrale che ne garantisce la robustezza nell'uso.
Confezione in scatola da 100 pezzi.

Tent pegs mod. «Export»

Manufactured in zinc-coated sheet-metal.
Width 10/10.
With central rib.
Very strong and resistant.

Packing in box of 100 pcs.

Articolo - Article	Lunghezza Length cm.	📦 gr.	Confezione Packing gr.	€/pc.	€/box
H 00 25 050	25	50	100		
H 00 30 078	30	70	100		

**Picchetti mod. «Export»**

Confezione SELF-SERVICE da 6 pezzi.

Tent pegs mod. «Export»

SELF-SERVICE packing of 6 pcs.

Articolo - Article	Lunghezza - Length cm.	Conf. - Packing gr.	€/Set 6 pz. - pcs.
H 00 25 330	25	330	
H 00 30 500	30	500	

**Picchetti mod. «Ciclope»**

Fabbricati in lamiera di acciaio zincata e tropicalizzata 15/10 spessore.
Provvisti di doppia nervatura che ne garantisce la robustezza nell'uso.
Muniti di labbro di ribattitura molto pronunciato per offrire massima resistenza anche su terreni duri.
Confezione da 50 pezzi.

Tent pegs mod. «Ciclope»

Manufactured in zinc-coated sheet-metal.
Width 15/10.
With central rib.
Very strong and resistant.

Packing in box of 50 pcs.

Articolo - Article	Lunghezza - Length cm.	📦 gr.	€/pc.	€/box
H 04 30 090	30	90		

**Picchetti mod. «Ciclope»**

Confezione SELF-SERVICE da 6 pezzi.

Tent pegs mod. «Ciclope»

SELF-SERVICE packing of 6 pcs.

Articolo - Article	Lunghezza - Length cm.	Conf. - Packing gr.	€/Set 6 pz. - pcs.
H 04 25 420	25	420	

Picchetti - Tent pegs

Martello con levapicchetti mod. «Gigante»

Mazzuola in robusto materiale plastico con manico in tubo metallico.
Provvisto di levapicchetti.
Confezione in scatola da 12 pezzi.

Hammer with tent peg extractor mod. «Gigante»

Made of strong synthetic rubber.
Metal made stick.
With tent peg extractor.
Packing in box of 12 pcs.

Articolo - Article	€/pc.
Z 09 00 380	



Picchetto a chiodo con rondella fermastuoia

Fabbricato in robusto filo di acciaio zincato tropicalizzato provvisto di rondelle.
Filo Ø 7 mm.
Confezione SELF-SERVICE da 6 pezzi

Nail tent peg with washer

Manufactured in strong zinc-coated steel.
For a full insertion in the ground.

Wire Ø 7 mm.
SELF-SERVICE packing of 6 pcs.

Articolo - Article	Lunghezza - Length cm.	Ø gr.	€/Set 6 pz. - pcs.
H 07 20 210	20	210	



Picchetti modello a croce

Fabbricato in robusto filo di acciaio zincato.
Filo Ø 7 mm.
Confezione in sacchetto da 50 pezzi.

Cross tent peg

Manufactured in strong zinc-coated steel.
Wire Ø 7 mm.
Packing in bag of 50 pcs. .

Articolo - Article	Lunghezza - Length cm.	Ø gr.	€/pc.	€/box
H 07 20 030	20	35		



Picchetti modello a croce

Confezione SELF-SERVICE da 6 pezzi.

Cross tent peg

SELF-SERVICE packing of 6 pcs.

Articolo - Article	Lunghezza - Length cm.	Conf. - Packing gr.	€/Set 6 pz. - pcs.
H 07 20 180	20	210	



Picchetti mod. «Golia»

Modello robustissimo.
Zincatura tropicalizzata.
Punta tagliata a fetta di salame.
Filo Ø 8 mm.
Confezione in scatole da 50 pezzi.

Tent pegs mod. «Golia»

Manufactured in zinc-coated steel.
Very strong and resistant.
With open hook.
Wire Ø 7 mm.
Packing in box of 50 pcs.

Articolo - Article	Lunghezza - Length cm.	Ø gr.	€/pc.	€/box
H 06 23 000	24	70		
H 06 30 000	30	105		



Picchetti mod. «Golia»

Confezione SELF-SERVICE da 6 pezzi.

Tent pegs mod. «Golia»

SELF-SERVICE packing of 6 pcs.

Articolo - Article	Lunghezza - Length cm.	Ø gr.	€/Set 6 pz. - pcs.
H 06 23 095	24	520	
H 06 30 125	30	700	



Spilloni in acciaio mod.«Standard»

Fabbricati in filo di acciaio zincato.
Filo Ø 4,5 mm.
Confezione da 100 pezzi.

Tent pegs mod. «Standard»

Manufactured in zinc-coated steel.
Wire Ø 4,5 mm.
Packing in box of 100 pcs.

Articolo - Article	Lunghezza - Length cm.	Ø gr.	€/pc.	€/box
H 06 24 030	24	30		
H 06 30 035	30	35		

Spilloni in acciaio mod.«Standard»

Confezione SELF-SERVICE da 12 pezzi.

Tent pegs mod. «Standard»

SELF-SERVICE packing of 12 pcs.

Articolo - Article	Lunghezza - Length cm.	Ø gr.	€/Set 12 pz. - pcs.
H 06 18 300	18	300	
H 06 24 360	24	360	



Elastico rettangolare adatto per la tensione delle camere interne delle tende

Fabbricato in gomma di prima qualità. Confezione SELF-SERVICE da 6 pezzi e in scatola da 10 confezioni.

Rectangular rubber stretcher for the interior of tents

Manufactured in high quality rubber. SELF-SERVICE packing of 6 pcs. and in box of 10 packs.

Articolo - Article	Lunghezza interna Inner length mm.	Larghezza Width mm.	Spessore Thickness mm.	€/Set 6 pz. - pcs.
Z 15 00 360	110	7	2	

Elastico adatto per la tensione delle basi delle tende

Fabbricato in gomma di prima qualità. Confezione SELF-SERVICE da 6 pezzi e in scatola da 10 confezioni.

Rubber stretcher for the ground of tents

Manufactured in high quality rubber. SELF-SERVICE packing of 6 pcs. and in box of 10 packs.

Articolo - Article	Lunghezza interna Inner length mm.	Larghezza Width mm.	Spessore Thickness mm.	€/Set 6 pz. - pcs.
Z 15 00 280	100	8	5	

Elastico rettangolare adatto per la tensione dei velari delle tende

Fabbricato in gomma di prima qualità. Confezione in busta da 100 pezzi.

Rectangular rubber stretcher for the window of tents

Manufactured in high quality rubber. Packing in bag of 100 pcs.

Articolo - Article	Lunghezza interna Inner length mm.	Larghezza Width mm.	Spessore Thickness mm.	€/pc.	€/box
Z 15 04 100	100	4	4		

Elastico rettangolare adatto per la tensione dei velari delle tende

Confezione SELF-SERVICE da 6 pezzi e in scatola da 10 confezioni.

Rectangular rubber stretcher for the window of tents

SELF-SERVICE packing of 6 pcs. and in box of 10 packs.

Articolo - Article	Lunghezza interna Inner length mm.	Larghezza Width mm.	Spessore Thickness mm.	€/Set 6 pz. - pcs.
Z 15 00 106	100	4	4	

Elastico di tensione regolabile a scaletta

Modello provvisto di fori. Fabbricato in gomma di prima qualità. Confezione SELF-SERVICE da 6 pezzi e in scatola da 10 confezioni.

Adjustable rubber stretcher

With holes. Suitable for adjusting. Manufactured in high quality rubber. SELF-SERVICE packing of 6 pcs. and in box of 10 packs.

Articolo - Article	Modello Model	Lunghezza Length mm.	Spessore Thickness mm.	€/Set 6 pz. - pcs.
Z 15 00 095	5 fori - holes	170	8 x 8	

made by 

Serie corde di tensione regolabili per tende (4 pz.)

Provviste di tenditori regolabili in alluminio. Confezione in busta da 4 pezzi e in scatola da 20 buste. Lunghezza corde di tensione: 4 mt.

Guy - ropes for tents (4 pcs.)

Manufactured with first quality rope. Supplied with adjustable alu stretchers. Packing in polybag of 4 pcs. and 20 bags in a box. Length 4 mt.

Articolo - Article	Ø mm.	gr.	€/Set 4 pz. - pcs.
Z 40 40 150	4,0	150	

Tenditori elastici per base tenda (6 pezzi)

Gancio in acciaio plastificato. Confezione in busta da 6 pezzi e in scatola da 10 buste.

Elastic tightener for tent base (6 pcs.)

Hook in plastic-covered steel. Packing in bag of 6 pcs. and in box of 10 bags.

Articolo - Article	Ø mm.	Lunghezza - Length cm.	€/Set 6 pz. - pcs.
Z 43 06 072	6,0	12	

Bottoni - Buttons

Occhioli e rondelle da ribadire foro ø 11 mm.

Provvisti di relativi attrezzi per il montaggio su tende campeggio, vele, imbarcazioni, indumenti etc. Confezione SELF-SERVICE da 15 occhioli e rondelle e in scatola da 5 confezioni.

Eyelets and studs hole ø 11 mm.

With tools for mounting on trailers, tents, boats, caravans, etc.

SELF-SERVICE packing of 15 studs and eyelets and in box of 5 packs.

Articolo - Article	Ø mm.	Confezione - Packing gr.	€/Blister 15 pz. - pcs.
E 05 41 370	11	145	



Bottoni a ribadire nichelati

Indicati per tende, verande, coperture.

Provvisti di relativo attrezzo per il montaggio. Confezione SELF-SERVICE da 10 serie e in scatola da 5 confezioni.

Chromium plated brass buttons

With tools for mounting on trailers, tents, boats, caravans, etc.

SELF-SERVICE packing of 10 sets and in box of 5 packs.

Articolo - Article	Ø mm.	Confezione - Packing gr.	€/Blister 10 pz. - pcs.
E 03 90 301	15	120	



Bottoni a ribadire con vite per applicazione a superfici rigide

Indicati per applicazione tessuto o teloni a superfici solide quali roulotte, imbarcazioni etc.

Provvisti di relativo attrezzo per il montaggio. Confezione SELF-SERVICE da 10 serie e in scatola da 5 confezioni.

Buttons with screws for rigid bottoms

Suitable for application of fabrics on surfaces such as caravans, boats, etc.

With tools for mounting on trailers, tents, boats, caravans. SELF-SERVICE packing of 10 sets and in box of 5 packs.

Articolo - Article	Ø mm.	Confezione - Packing gr.	€/Blister 10 pz. - pcs.
E 03 90 211	15	130	



Tornichetti girevoli inossidabili per capotte e tendalini

L'occhiolo si fissa a pressione nella parte in tela.

Indicati per tendalini e imbarcazioni in quanto inossidabili.

Confezione SELF-SERVICE da 4 serie e in scatola da 5 confezioni.

Studs in stainless steel for sun-tops, canvas hood

Press studs.

Suitable for sun-tops, boats, caravans.

SELF-SERVICE packing of 4 sets and in box of 5 packs.

Articolo - Article	Modello - Model	Confezione Packing gr.	€/Blister 4 pz. - pcs.
E 05 00 150	Applicazione a pressione Application with pression	135	



Bottoni in ottone cromato per capottine e tendalini

A pressione.

Confezione in blister da 10 pezzi.

Chromium plated brass buttons press stud

For tops and bimini.

Packing in blister of 10 pcs.

Articolo - Article	Modello - Model	Tipo - Type	€/Blister 10pcs.
N 58 01 034	A vite autofilett.-Threading cross screw	Male	
N 58 02 034	B A vite e dado - Screw nut	Male	
N 58 03 034	C Con piastrina-With clamp	Male	
N 58 04 034	D Aggraffatura a tessuto-To the cloth	Male	
N 58 06 034	E Ad avvitamento-Screw on type	Female	
N 58 05 000	F Attrezzo manuale - Hand tool	-	

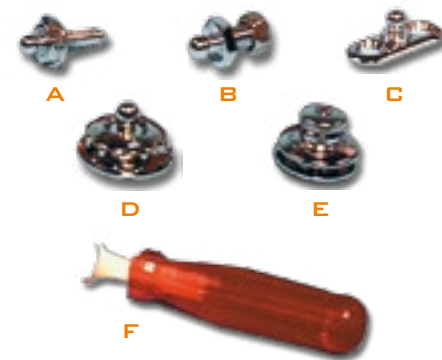

Bottoni in acciaio inox per capottine

In acciaio inox.

Confezione in sacchetto da 200 pezzi.

Stainless steel press-buttons for folding tops

In stainless steel.

Packing in polybag of 200 pcs.

Articolo - Article	Tipo - Type	Modello - Model	€/pc.	€/box
N 58 01 004	1	Maschio - Male		
N 58 02 045	2	Borchia		
N 58 03 035	3	Borchia femmina		
N 58 17 004	4	Borchia ø 17 mm.		
N 58 14 005	5	Borchia ø 14 mm.		



made by **Borchie a montaggio rapido**

Fabbricate in plastica.
Di facile ed istantaneo montaggio, indicate per il fissaggio di teloni e tende.

Foro Ø 15 mm.

Confezione in sacchetto da 50 pezzi.

Plastic grommet

Suitable for fix the canvas cover to the boats, tents in plastic.

Fastening with a hammer.

Hole Ø 15 mm.

Packing in polybag of 50 pcs.

Articolo - Article	Colore - Colour	gr.	€/pc.	€/box
A 22 14 020	Blu - Blue	10		
A 22 16 020	Bianco - White	10		
A 22 17 020	Nero - Black	10		

Confezione su cartone da esposizione da 12 pezzi, e in scatola da 6 cartoni.

Packing in skin pack cardboard of 12 pcs. and in box of 6 card-boards.

Articolo - Article	Colore - Colour	€/Cartella 12 pz. Card-board 12 pcs.
A 22 14 000	Blu - Blue	
A 22 16 000	Bianco - White	
A 22 17 000	Nero - Black	

made by 

A

B

Ganci in nylon milleusi

Fissaggio mediante viti.

Confezione in busta da 50 pezzi.

Multipurpose nylon hooks

Fixing by screws.

Packing in box of 50 pcs.

Articolo - Article	Tipo - Type	€/pc.	€/box
C 29 00 080	A		
A 21 00 020	B		

Accessori - Accessories

PSPD **Impermeabilizzante spray al silicone per tende**

Un solo trattamento è sufficiente per garantire la perfetta tenuta d'acqua dei tessuti trattati. Confezione in scatola da 24 bombolette.

Tent water-proofer

Prevents against humidity and keeps the tent supple.

Resisting to rain and snow.

Packing in box of 24 aerosol.

Articolo - Article	Modello - Model	gr.	€/pc.
E 08 00 600	Grande - Large	600	

Tela adesivizzata per riparazione tende

Tela adesivizzata per la riparazione di tende, senza uso di ferro da stiro o colla.

Confezione in rotoli da mt 4,5 in confezione singola self-service.

Repair adhesive tape for tent

Suitable for repair of tents.

No use of flat-iron or glue required.

Single packing in roll of 4,5 m. self-service.

Articolo - Article	Larghezza - Widht mm.	Colore - Colour	€/pc.
E 46 52 009	52	Bianco - White	
E 49 52 009	52	Rosso - Red	
E 48 52 009	52	Blu - Blue	
E 43 52 009	52	Arancio - Orange	

Tappo e valvola di ricambio per battelli in Pvc

Fabbricati in materiale plastico. Confezione in scatole da 10 serie.

Spare plug and valve for Pvc inflatables

Manufactured in plastic. Packing in box of 10 series.

Articolo - Article	Ø mm.	Altezza - Height mm.	gr.	€/pc.
Z 14 00 024	24	15	50	



0,130 gr./Mq



0,130 gr./Mq



0,200 gr./Mq



Teloni in rafia

Fabbricato in PE.
Rinforzo con corda in PP interna.
Occhioli in alluminio ogni 100 cm.

Covers in raffia

Made in PE.
Support with internal rope in PP.
Aluminium eyes every 100cm.

Articolo - Article	peso -Weight gr/m2	↑ mt.	Colore esterno	Colore interno	€/mt. ²	€/pc.	kg.
O 40 13 023	0,130	2x3	azzurro	Bianco			0.78
O 40 13 033	0,130	3x3	azzurro	Bianco			1.17
O 40 13 034	0,130	3x4	azzurro	Bianco			1.56
O 40 13 036	0,130	3x6	azzurro	Bianco			2.34
O 40 13 044	0,130	4x4	azzurro	Bianco			2.08
O 40 13 045	0,130	4x5	azzurro	Bianco			2.60
O 40 13 048	0,130	4x8	azzurro	Bianco			4.16
O 40 13 057	0,130	5x7	azzurro	Bianco			4.55
O 40 13 068	0,130	6x8	azzurro	Bianco			6.24
O 41 13 023	0,130	2x3	verde	Bianco			0.78
O 41 13 033	0,130	3x3	verde	Bianco			1.17
O 41 13 034	0,130	3x4	verde	Bianco			1.56
O 41 13 036	0,130	3x6	verde	Bianco			2.34
O 41 13 044	0,130	4x4	verde	Bianco			2.08
O 41 13 045	0,130	4x5	verde	Bianco			2.60
O 41 13 048	0,130	4x8	verde	Bianco			4.16
O 41 13 057	0,130	5x7	verde	Bianco			4.55
O 41 13 068	0,130	6x8	verde	Bianco			6.24
O 40 20 037	0,200	3x7	Blue	Nero			4.20
O 40 20 045	0,200	4x5	Blue	Nero			4.00
O 40 20 048	0,200	4x8	Blue	Nero			6.40
O 40 20 049	0,200	4x9	Blue	Nero			7.20
O 40 20 057	0,200	5x7	Blue	Nero			7.00
O 40 20 068	0,200	6x8	Blue	Nero			9.60
O 40 20 106	0,200	10x6	Blue	Nero			12.00
O 40 20 128	0,200	12x8	Blue	Nero			19.20

Bandiere - Flags



A



B

Codice internazionale bandiere europee in stoffa di poliestere

Confezione da 10 pezzi.

Articolo - Article	cm.	Mod.	€/pc.
N 54 20 030	20 x 30	B (Euro-Italy)	
N 54 20 031	20 x 30	A (Europe)	

European flag international code made of polyester fabric

Packing of 10 pcs.



Bandiera italiana

Confezione in busta da 10 pezzi. Packing in polybag of 10 pcs.
In stoffa di poliestere «Sottile» Made of «Thin» polyester fabric

Italian flag

Articolo - Article	cm.	€/pc.
N 21 20 300	20 x 30	

Bandiere nazionali estere in poliestere - Polyester nationality flags

- Confezione da 10 pezzi
- Packing of 10 pcs.

Austria

Articolo - Article	cm.	€/pc.
N 54 02 030	20x30	



Olanda - The Netherlands

Articolo - Article	cm.	€/pc.
N 54 16 030	20x30	



Belgio - Belgium

Articolo - Article	cm.	€/pc.
N 54 07 030	20x30	



Polonia - Poland

Articolo - Article	cm.	€/pc.
N 54 24 030	20x30	



Croazia - Croatia

Articolo - Article	cm.	€/pc.
N 54 11 030	20x30	



Russia

Articolo - Article	cm.	€/pc.
N 54 19 030	20x30	



Francia - France

Articolo - Article	cm.	€/pc.
N 54 04 030	20x30	



Slovenia

Articolo - Article	cm.	€/pc.
N 54 12 030	20x30	



Germania - Germany

Articolo - Article	cm.	€/pc.
N 54 01 030	20x30	



Svizzera - Switzerland

Articolo - Article	cm.	€/pc.
N 54 05 030	20x30	



Gran Bretagna Great Britain

Articolo - Article	cm.	€/pc.
N 54 10 030	20x30	



Ungheria - Hungary

Articolo - Article	cm.	€/pc.
N 54 09 030	20x30	



Bandiera pirata

Pirate flag

Articolo - Article	cm.	€/pc.
N 54 34 030	20x30	



Lucchetti - Padlocks



Lucchetto in ottone con arco inox

Particolarmente robusto e resistente. Munito di chiavi in ottone cromato.
Confezione in scatole da 12 pezzi.

Brass padlock with SS arc

Very strong and resistant. With chromed brass keys set.
Packing in box of 12 pcs.

Articolo - Article	Dimensioni arco - Arc size mm.	gr.	€/pc.
N 02 00 030	30 x 20	130	

made by TREM



Lucchetto arco lungo in ottone

Particolarmente robusto e resistente. Munito di chiavi in ottone cromato.
Confezione in scatole da 12 pezzi.

Brass padlock with long arc

Very strong and resistant. With chromed brass keys set.
Packing in box of 12 pcs.

Articolo - Article	Dimensioni arco - Arc size mm.	gr.	€/pc.
N 02 00 150	50 x 34	150	

Accessori vari

Miscellaneous accessories





Cinghie di carico - Adjustable belts



Cinghia regolabile 25 mm.
mod. «Fast - Cargo»

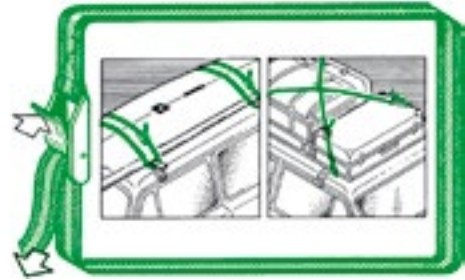

Adjustable belt 25 mm.
«Fast - cargo»

Articolo - Item	← cm.	€/ 	 kg.
C 31 25 150	150		0,150
C 31 25 250	250		0,160
C 31 25 400	400		0,210



Cinghia regolabile in poliestere
mod. «Easy - Cargo» munita di
fibbia autobloccante e di ganci
terminali

Adjustable polyester belt
provided with selflocking
buckle mod. «Easy - cargo»
with end hooks

Articolo - Item	Modello	fettuccia mm.	← cm.	€/ 	 kg.
C 15 25 300	-	25	300		0,450
C 15 25 450	-	25	450		0,480
C 15 25 600	-	25	600		0,515



Cinghia regolabile mm. 25
mod. «Easy - Cargo»
munita di fibbia autobloccante
e di ganci terminali in acciaio
inox Aisi 316

Adjustable belt provided with
selflocking buckle
stainless steel Aisi 316
mod. «Easy - cargo»
with end hooks

Articolo - Item	← cm.	€/ 	 kg.
C 15 32 600	600		0,510

Aisi 316 Stainless steel



Reti e ragni fissabagagli - Luggage nets



Ragno a 6 bracci fissabagagli
per auto e moto

Spider 6 arms for cars and
moto

Ganci in acciaio plastificato.
Ø 8 mm.

Plastic covered steel hooks.
Ø 8 mm.

Articolo - Item	← cm.	€/ pc.	 kg.
A 13 08 080	80		0,190

N.B. Altre misure su richiesta e per quantitativi
Further sizes on demand



Corde elastiche fissabagagli «SERIE TREM» Rubber straps for luggage «SERIE TREM»

Ricoperte in polietilene.
Ganci in acciaio plastificato.
Ø 8 mm.

Covered with polyethylen.
Plastic covered steels hooks.
Ø 8 mm.

Articolo - Item	←→ cm.	📦 pcs.	€/pc.	€/box	📦 kg.
A 11 08 040	40	10			0,050
A 11 08 060	60	10			0,055
A 11 08 080	80	10			0,060
A 11 08 100	100	10			0,067
A 11 08 120	120	10			0,075
A 11 08 150	150	10			0,080
A 11 08 200	200	10			0,090

Corde elastiche fissabagagli «SERIE TREM» Rubber straps for luggage «SERIE TREM»

Ricoperte in polietilene.
Ganci in acciaio plastificato.
Ø 10 mm.

Covered with polyethylen.
Plastic covered steels hooks.
Ø 10 mm.

Articolo - Item	←→ cm.	📦 pcs.	€/pc.	€/box	📦 kg.
A 11 10 080	80	10			0,085
A 11 10 100	100	10			0,090
A 11 10 150	150	10			0,120
A 11 10 200	200	10			0,140

Corde traino auto - Nylon tow ropes

INDISPENSABILE A BORDO
NECESSARY ON BOARD

Corde traino auto con ammortizzatore

Provvista al centro di ammortizzatore e bandierina. Munita all'estremità di pratici ganci di attacco.

Ø 10 mm.

Articolo - Item	←→ cm.	€/pc.	📦 kg.
A 08 10 350	350		0,800

Tow rope for car with shock absorber

Provided with shock-absorber and mark in the center. With easy locking hooks at the extremity.

Ø 10 mm.

Corde elastiche fissabagagli - Rubber straps

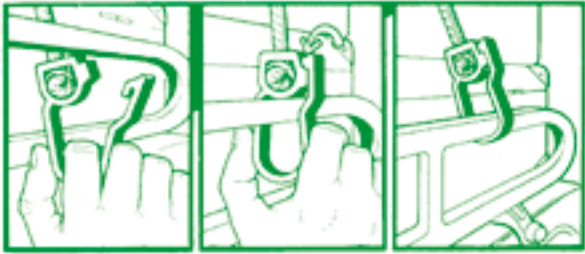

SERIE ANTINFORTUNISTICA ANTI-JOB-INJURIES



Corde elastiche con ganci antinfortunistici in nylon mod. «SICUR CARGO»

Rubber straps with nylon hooks mod. «SICUR CARGO»

Ganci muniti di arresto di sicurezza, in resina acetilica. Ganci infrangibili ed antinfortunistici.

Hooks with security locking system.

Confezione in busta da 10 pz.

They are easy to use and avoid every risk of accident.

Ø 8 mm.

Packing: 10 pcs. in polybag.
Ø 8 mm.

Articolo - Item	←→ cm.	📦 pcs.	€/pc.	€/box	📦 kg.
A 35 08 083	80	10			0,090
A 35 08 103	100	10			0,100
A 35 08 153	150	10			0,120

Corde elastiche milleusi con ganci in nylon

Rubber straps provided with nylon hooks

Fabbricate in delrin. Infrangibili ed antinfortunistici. Confezione in colori assortiti.

Made of delrin. Unbreakable and accident prevented. Packing in mixed colours.

Ø 8 mm.

Ø 8 mm.

Articolo - Item	←→ cm.	📦 pcs.	€/pc.	€/box	📦 kg.
A 31 08 060	60	10			0,070
A 31 08 100	100	10			0,085



N.B. Altre misure su richiesta e per quantitativi
Further size on demand

Carichi pesanti - Heavy loads



Corde elastiche per carichi pesanti

Rubber straps special for heavy loads

Indicate per carichi voluminosi, pesanti e per fissare imbarcazioni sulle auto.

For bulky and heavy loads and to fasten boats on motor-cars.

Ø 14 mm.

Ø 14 mm.

Articolo - Item	←→ cm.	€/pc.	📦 kg.
C 14 14 150	150		0,370
C 14 14 250	250		0,460

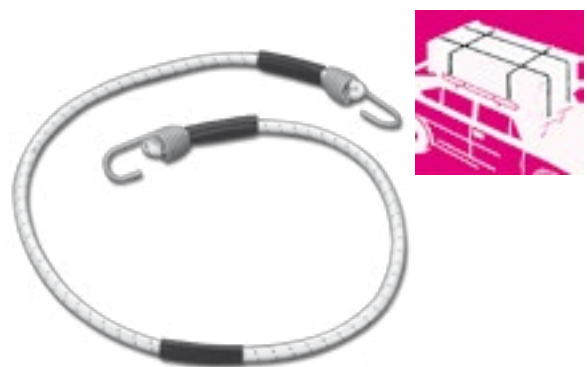

Corde elastiche per usi industriali e centinatura Shock cords for industrial application and lorry centering

CORDA ELASTICA FABBRICATA INTERAMENTE IN GOMMA DI PRIMA QUALITÀ RICOPERTA IN MONOFILO DI POLIETILENE

SHOCK CORD FULLY MANUFACTURED OF HIGH QUALITY RUBBER COVERED WITH POLYETHYLENE MONOFILAMENT THREAD



SERIE «EXTRA»

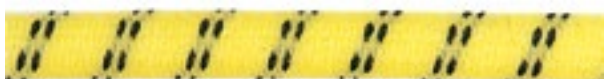

SERIE «ECONOMY»



CORDA ELASTICA INDICATA PER CENTINATURA AUTOCARRI E CARRELLI APPENDICE

Ricoperta in polietilene e composta all'interno di lattice di gomma che garantisce nel tempo un'elasticità costante e una perfetta tensione dei teloni o dei carichi.

COLORE NERO

Articolo - Item	Ø mm.	mt.	€/mt.	€/kg.
A 18 04 080	4	100		
A 18 06 080	6	100		

COLORE ROSSO

Articolo - Item	Ø mm.	mt.	€/mt.	€/kg.
A 18 06 082	6	100		
A 18 08 082	8	200		
A 18 10 082	10	100		

COLORE BLU

Articolo - Item	Ø mm.	mt.	€/mt.	€/kg.
A 18 06 075	6	100		
A 18 08 075	8	200		
A 18 10 075	10	100		

COLORE VERDE

Articolo - Item	Ø mm.	mt.	€/mt.	€/kg.
A 18 06 085	6	100		*
A 18 08 085	8	200		
A 18 10 085	10	100		

COLORE BIANCO

Articolo - Item	Ø mm.	mt.	€/mt.	€/kg.
A 18 06 074	6	100		*
A 18 08 074	8	200		

COLORE GIALLO

Articolo - Item	Ø mm.	mt.	€/mt.	€/kg.
A 18 08 077	8	200		*

COLORE GRIGIO

Articolo - Item	Ø mm.	mt.	€/mt.	€/kg.
A 18 08 079	8	200		

COLORE NERO

Articolo - Item	Ø mm.	mt.	€/mt.	€/kg.
C 19 06 081	6	100		
C 19 08 081	8	200		

SPECIFIC RANGE OF SHOCK CORD IN REEL FOR LORRY CENTERING KNITTED COVER

Covered outside with polyethylene yarn and with latex inside. For a better elasticity and for a perfect tension of the lorry curtain.

BLACK COLOUR

mt.	€/mt.	€/kg.
100		
100		

RED COLOUR

mt.	€/mt.	€/kg.
100		
200		
100		

BLUE COLOUR

mt.	€/mt.	€/kg.
100		
200		
100		

GREEN COLOUR

mt.	€/mt.	€/kg.
100		*
200		
100		

WHITE COLOUR

mt.	€/mt.	€/kg.
100		*
200		

YELLOW COLOUR

mt.	€/mt.	€/kg.
200		*

GREY COLOUR

mt.	€/mt.	€/kg.
200		

BLACK COLOUR

mt.	€/mt.	€/kg.
100		
200		

* Disponibile su richiesta - Available on request

Corde elastiche speciali «Marina» - Shock cords



100% Polyester

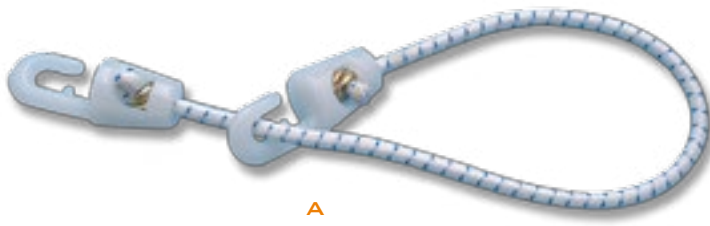

A

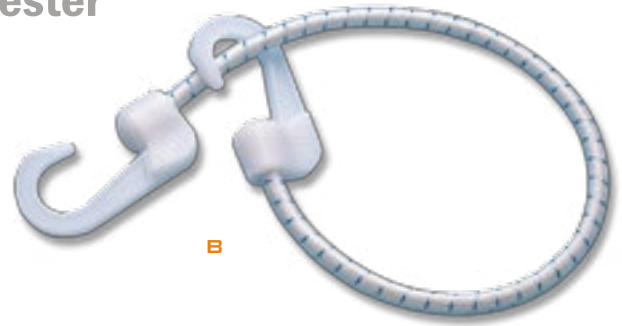

B



Corde elastiche con ganci in nylon

Shock-cords with nylon hooks

Articolo - Item	Mod.	Ø mm.	← cm.	kg.	€/pc.	€/box
C 00 04 020	A	4	20	0,040		
C 00 04 030	A	4	30	0,060		
C 00 06 030	A	6	30	0,080		
C 00 08 050	A	8	50	0,210		
C 00 10 100	B	10	100	0,500		

Corda elastica speciale «Marina»
Colore bianco filo segnale blu navy

«Marina» special shock cord
white colour Navy blue threads

Corda elastica composta all'interno di lattice di gomma e ricoperta all'esterno di multifilamenti di poliestere.

Inside of rubber and covered by polyester. White with blue yarn identification.

Articolo - Item	Ø mm.	mt.	€/mt.	kg.
C 10 04 050	4	50		0,500
C 10 05 050	5	50		1,000
C 10 06 050	6	50		1,350
C 10 08 050	8	50		2,300
C 10 10 050	10	50		3,650
C 10 12 050	12	50		5,000
C 10 14 050	14	50		7,000
C 10 16 050	16	50		
C 10 18 050	18	50		
C 10 20 050	20	50		

Polyester
50 mt.



Corda elastica «Color»

«Color» shock cord

Corda elastica composta all'interno di lattice di gomma e ricoperta all'esterno di multifilamenti di poliestere.

Inside covered with rubber latex. Outside covered with polyester multifilament.

Articolo - Item	Colore Colour	Ø mm.	mt.	€/mt.	kg.
C 77 04 000	Giallo-Yellow	4	100		
C 77 05 000	Giallo-Yellow	5	100		2,000
C 77 06 000	Giallo-Yellow	6	100		3,000
C 78 04 000	Rosso-Red	4	100		
C 78 05 000	Rosso-Red	5	100		2,000
C 78 06 000	Rosso-Red	6	100		3,000
C 75 04 000	Blu-Blue	4	100		
C 75 05 000	Blu-Blue	5	100		2,000
C 75 06 000	Blu-Blue	6	100		3,000

Polyester



Olimpic



Corda elastica colore nero

White colour shock cord

Corda elastica composta all'interno di lattice di gomma e ricoperta all'esterno di multifilamenti di poliestere.

Bright colours. Inside covered with rubber latex. Outside covered with polyester multifilament.

Articolo - Item	Ø mm.	mt.	€/mt.	kg.
C 80 03 000	3	100		0,800
C 80 04 000	4	100		1,000
C 80 05 000	5	100		2,000
C 80 06 000	6	100		3,000
C 80 08 000	8	100		4,500

Polyester



Olimpic



Polyester



Filo speciale per cucire le vele

Fabbricato in poliestere.

Tackle yarn paraffined

Manufactured in polyester.

Articolo - Item	Ø mm.	Paraffinato Paraffined	Colore Colour	mt.	€/mt.	kg.
F 23 05 100	0,5	Si-Yes	Bianco-White	100		0,070
F 23 01 050	1,0	No	Bianco-White	50		0,060
F 23 15 035	1,5	Si-Yes	Bianco-White	35		0,060
F 23 80 100	1,0	Si-Yes	Nero-Black	100	*	
F 23 75 100	1,0	Si-Yes	Blu-Blue	100	*	

Polyester



Treccia in poliestere colore bianco in confezione «Self-service»

White colour polyester rope Self-service packing

Articolo - Item	Ø mm.	mt.	€/mt.	kg.
T 39 02 050	2	50	*	0,110
T 39 25 050	2,5	50		0,210
T 39 03 050	3	50		0,275
T 39 04 040	4	40		0,368
T 39 05 030	5	30	*	0,600



Corda elastica bianca confezione «Self-service» da 20 mt.

Shock cord white colour «Self-service» packing 20 mt.

Articolo - Item	Ø mm.	mt.	Colore-Colour	€/mt.	kg.
C 21 03 020	3	20			0,160

Polypropylene



Treccia usi vari confezione «SELF-SERVICE» colori assortiti

Braided rope in «SELF-SERVICE» packing assorted colours

Confezione in scatola da 6 bobine.

Packing in box of 6 reels.

Articolo - Item	Ø mm.	mt.	€/mt.	kg.
T 10 04 020	4	20		0,119
T 10 06 020	6	20		0,420
T 10 08 015	8	15		0,600
T 10 10 011	10	10		0,510



Doppia treccia colore bianco confezione in bobina

Polypropylene rope colour white in reel

Fabbricata in multifilamenti di polipropilene stabilizzato. Massima resistenza, minimo allungamento.

Multifilament double braided line. Supplied with inner core. High resistance, low elongation.

Articolo - Article	Ø mm.	mt./bobina mt./reel	Resistenza Resistance Kg.	€/Mt.	€/mt.
T 10 04 000	4	200	190		
T 10 05 000	5	200	350		
T 10 06 000	6	200	400		
T 10 08 000	8	150	750		

* Disponibile su richiesta - Available on request

Trecce multiusi - Multipurpose ropes

Polyester



Olimpic

«Ibiza Multicolor» doppia treccia
100% poliestere

«Ibiza Multicolor» braided rope
100% coloured polyester

Articolo - Item	Articolo - Item	Articolo - Item	Articolo - Item	Ø mm.	mt.	kg.	€/mt.
T 82 03 000	T 75 03 000	T 76 03 000	T 78 03 000	3	200	0,900	
T 82 04 000	T 75 04 000	T 76 04 000	T 78 04 000	4	200	2,630	

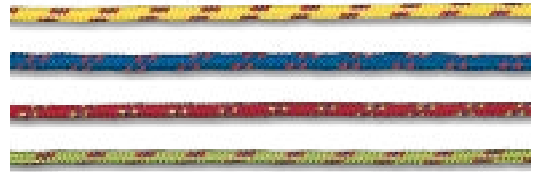

Treccia in poliestere colorato
confezione in bobinette «self-service»
trecciata 16 fusi

Braided rope
made of colored polyester,
packaging in «self-service» reels



Articolo - Item	Colore-Colour	Ø mm.	mt.	daN	kg.	€/mt.
T 82 25 022	Giallo-Yellow	2,5	22	130	0,100	
T 78 25 022	Verde-Green	2,5	22	130	0,100	
T 76 25 022	Rosso-Red	2,5	22	130	0,100	
T 75 03 020	Blu-Blue	3	20	140	0,100	
T 78 03 020	Verde-Green	3	20	140	0,100	
T 76 03 020	Rosso-Red	3	20	140	0,100	
T 75 04 013	Blu-Blue	4	13	250	0,180	
T 82 04 013	Giallo-Yellow	4	13	250	0,180	
T 76 04 013	Rosso-Red	4	13	250	0,180	

Polyester



Polyester



Espositore da tavolo completo di
24 bobine assortite in diametri e colori

Bank rack complete with 24 reels
in assorted colours and diameters

Articolo - Item	Modello - Model	€/pc.
T 75 00 000	«Ibiza Multicolor»	188,00

Espositore completo di 24 bobine - Rack complete with 24 reels

Polyester



Olimpic

«Ibiza Uni Color» doppia treccia
100% poliestere

«Ibiza Uni Color» braided rope
100% polyester

Articolo - Item	Colore-Colour	Ø mm.	kg.	mt.	€/mt.
T 38 02 200	Bianco-White	2	0,670	200	
T 38 03 000	Bianco-White	3	0,900	200	
T 94 02 000	Nero-Black	2	0,670	200	
T 94 03 000	Nero-Black	3	0,900	200	
T 95 02 000	Blu-Blue	2	0,670	200	
T 95 03 000	Blu-Blue	3	0,900	200	
T 96 02 000	Rosso-Red	2	0,670	200	
T 96 03 000	Rosso-Red	3	0,900	200	
T 97 02 000	Giallo-Yellow	2	0,670	200	
T 97 03 000	Giallo-Yellow	3	0,900	200	



Treccia in poliestere nuova serie
«Ibiza Color» in bobinette «Self-service»

Braided rope made of colored polyester,
packaging in «self-service» reels



Articolo - Item	Colore-Colour	Ø mm.	kg.	mt.	€/mt.
T 94 02 030	Nero-Black	2	0,100	30	
T 95 02 030	Blu-Blue	2	0,100	30	
T 38 02 030	Bianco-White	2	0,100	30	
T 94 03 020	Nero-Black	3	0,100	20	
T 97 03 020	Giallo-Yellow	3	0,100	20	
T 95 03 020	Blu-Blue	3	0,100	20	
T 96 03 020	Rosso-Red	3	0,100	20	
T 38 03 020	Bianco-White	3	0,100	20	



Espositore da tavolo completo di
24 bobine assortite in diametri e colori

Bank rack complete with 24 reels
in assorted colours and diameters

Articolo - Item	Modello - Model	€/pc.
T 15 00 000	«Ibiza Color»	

Espositore completo di 24 bobine - Rack complete with 24 reels



Polyester



Cima da ancora trecciata - Double braided rope



Olimpic
made by TREM

Polyester

Treccia in poliestere serie Standard

Confezione in bobine.
Vendita a bobine.

Standard series polyester rope

Packing on reels.
Sales on reel.

Articolo - Item	Articolo - Item	Ø mm.	mt.	Kg.
T 09 05 180 R	T 09 05 001 R	5	500	7,6
T 09 06 180 R	T 09 06 001 R	6	400	8,9
T 09 08 180 R	T 09 08 001 R	8	400	15,15
T 09 10 180 R	T 09 10 001 R	10	200	11
T 09 12 180 R	T 09 12 001 R	12	200	15,6
T 09 14 180 R	T 09 14 001 R	14	200	22
T 09 16 180 R	T 09 16 001 R	16	170	24,2



Olimpic
made by TREM

Polyester

SAIPAM

«Trem Saipam» treccia in poliestere Colore bianco - filo segnale blu trecciata 16 e 24 fusi

Fabbricata in multifilamenti di poliestere.
Buona resistenza. Non galleggiante.

Polyester rope white colour with tracer trade blue 16/24 plait «Saipam»

Polyester multifilament braided line.
Not floating.

Articolo - Item	Ø mm.	daN	mt.	€/mt.	kg.
T 10 04 010	4	350	200		1,860
T 10 06 010	6	600	200		4,900
T 10 08 010	8	900	150		7,050
T 10 10 010	10	1500	150		11,550
T 10 12 010	12	1700	100		10,100

Treccia avviamento motori
Rope to start outboard motor

Nylon

made by TREM



«Trem Starter» treccia speciale di ricambio per avviamento motori fuoribordo in nylon bianco

«Trem Starter» special spare rope to start outboard motor in white nylon

Articolo - Item	Ø mm.	mt.	daN	€/mt.	kg.
T 04 03 000	3,5	100	350		0,900
T 04 04 000	4	100	450		1,150
T 04 05 000	5	100	550		1,800

Treccia fucili subacquei
Rope for submarine guns

Polypropylene

made by TREM



Treccia di ricambio per fucili subacquei in polipropilene nero

Spare rope for submarine guns in black polypropylene

Articolo - Item	Ø mm.	mt.	€/mt.	kg.
T 06 15 000	1,5	400		0,480
T 06 02 000	2	400		0,720
T 06 25 000	2,5	400		1,400
T 06 03 000	3	200		0,800
T 06 04 000	4	200		1,300

* Disponibile su richiesta - Available on request



► Non galleggiante - Not floating

BALMORAL WHITE

High tenacity Polyester

Olimpic

«Trem Balmoral» cima in poliestere ritorta 3 capi

«Trem Balmoral» 3-strand polyester mooring rope

Articolo - Item	€/mt.	€/m	Ø mm.	mt.	↑ daN.	kg.
T 50 06 000			6	200	500	7,600
T 50 08 000			8	200	900	13,400
T 50 10 000			10	200	1300	16,490
T 50 12 000			12	200	1900	22,000
T 50 14 000			14	100	2600	15,000
T 50 16 000			16	100	3300	18,500
T 50 18 000			18	100	4300	22,000

Articolo - Item	€/mt.	€/m	Ø mm.	mt.	↑ daN.	kg.
T 50 20 000			20	100	5200	27,000
T 50 22 000		*	22	100	5600	33,000
T 50 24 000		*	24	100	6500	37,000
T 50 26 000		*	26	100	7700	45,000
T 50 28 000		*	28	100	8600	50,000
T 50 30 000		*	30	100	9200	60,000
T 50 32 000		*	32	100	10000	68,000



► Non galleggiante - Not floating

BALMORAL BLACK

High tenacity Polyester

Olimpic

«Trem Balmoral» cima in poliestere ritorta 3 capi

«Trem Balmoral» 3-strand polyester mooring rope

Articolo - Item	€/mt.	€/m	Ø mm.	mt.	↑ daN.	kg.
T 52 08 000			8	200	780	13,400
T 52 10 000			10	200	1140	16,490
T 52 12 000			12	200	1660	22,000
T 52 14 000			14	100	2280	15,000
T 52 16 000			16	100	2890	18,500
T 52 18 000			18	100	3760	22,000

Articolo - Item	€/mt.	€/m	Ø mm.	mt.	↑ daN.	kg.
T 52 20 000			20	100	4200	27,000
T 52 22 000		*	22	100	4700	33,000
T 52 24 000		*	24	100	5500	37,000
T 52 26 000		*	26	100	6740	45,000
T 52 28 000		*	28	100	7000	50,000
T 52 30 000		*	30	100	8310	60,000
T 52 32 000		*	32	100	8750	68,000



► Non galleggiante - Not floating

BALMORAL GREY

High tenacity Polyester

Olimpic

«Trem Balmoral» cima in poliestere ritorta 3 capi

«Trem Balmoral» 3-strand polyester mooring rope

Articolo - Item	€/mt.	€/m	Ø mm.	mt.	↑ daN.	kg.
T 51 10 000		*	10	200	1000	16,490
T 51 12 000		*	12	200	1660	22,000
T 51 14 000		*	14	100	2280	15,000
T 51 16 000		*	16	100	2890	18,500
T 51 18 000		*	18	100	3760	22,000
T 51 20 000		*	20	100	4200	27,000

Articolo - Item	€/mt.	€/m	Ø mm.	mt.	↑ daN.	kg.
T 51 24 000		*	24	100	6000	37,000
T 51 26 000		*	26	100	8500	45,000
T 51 28 000		*	28	100	9000	50,000
T 51 30 000		*	30	100	11000	60,000
T 51 32 000		*	32	100	12000	68,000



► Non galleggiante - Not floating

BALMORAL BLUE

High tenacity Polyester

Olimpic

«Trem Balmoral» cima in poliestere ritorta 3 capi

«Trem Balmoral» 3-strand polyester mooring rope

Articolo - Item	€/mt.	€/m	Ø mm.	mt.	↑ daN.	kg.
T 51 06 075			6	200	440	16,490
T 51 08 075			8	200	780	22,000
T 51 10 075			10	200	1140	15,000
T 51 12 075			12	200	1660	18,500
T 51 14 075			14	100	2280	22,000
T 51 16 075			16	100	2890	27,000
T 51 18 075			18	100	3760	22,000

Articolo - Item	€/mt.	€/m	Ø mm.	mt.	↑ daN.	kg.
T 51 20 075			20	100	4200	27,000
T 51 22 075		*	22	100	4700	33,000
T 51 24 075		*	24	100	5500	37,000
T 51 26 075		*	26	100	6740	45,000
T 51 28 075		*	28	100	7000	50,000

* Disponibile su richiesta - Available on request



Contametri manuale

Rope counter

Articolo - Item	Adatto per - Adapt for	€/pc.	kg.
F 01 00 024	Corde fino a 24mm- Up to 24mm rope		



Telaio da banco completo di contametri per misurazione corde e trecce da Ø 3 a Ø 24mm.

Countmeter for ropes measurement from Ø 3 up to Ø 24mm.

Attrezzo adatto per la misurazione di corde munito di levetta per l'azzeramento.

Very useful for measurement of any diameter of rope. Possibility of zero setting each time.

Articolo - Item	Modello - Model	€/pc.	kg.
F 01 00 060	Completo - Complete		1,050



Cesoia speciale taglia corda elettrica con lama

Electric rope cutter with blade

120V./230V.
Modello originale tedesco.

120V./230V.
Made in Germany.

Articolo - Item	Confezione - Packing	€/pc.	kg.
F 02 00 110	Cesoia con lama - Cutter with blade		1,100
F 03 00 011	Lama di ricambio - Spare blade		0,110



Cesoia taglia cime modello economico

Rope cutter economic model

60W. 120V./230V.

60W. 120V./230V.

Articolo - Item	Confezione - Packing	W.	€/pc.	kg.
F 02 79 803	Cesoia con lama Cutter with blade	60		1,100
F 03 79 102	Lama di ricambio Spare blade	-		0,030

Accessori per centinatura - Accessories for lorry centering

made by 



Ganci in acciaio plastificato

Plastified steel hooks

Confezione in busta da 50 pezzi. Packing in polybag of 50 pcs.

Articolo - Article	Ø mm.	Colore - Colour	gr.	€/pc.	€/box
A 20 06 160	6	Verde - Green	20		
A 20 00 200	8	Arancio - Orange	22		
A 20 00 250	10	Blu - Blue	25		

made by 



Ganci autobloccanti per corda elastica

Self-tailing snap hook for shock cord

In nylon. Colore nero e bianco.
Confezione in busta da 50 pezzi.

Made of black-white coloured nylon.
Packing in polybag of 50 pcs.

Articolo - Article	Corda elastica Elastic cord Ø mm.	Colore - Colour	€/pc.	€/box
C 28 05 080	5 - 6	Nero - Black		
C 26 08 019	8	Nero - Black		
C 28 05 074	5 - 6	Bianco - White		

Ganci e borchie - Clamp rings and hooks



Ganci speciali in nylon «Colore bianco»

Per applicazioni industriali.
Montaggio tramite nodo.

Special nylon hooks «White colour»

Knot fitting.

Articolo - Item	Foro Hole Ø mm.	€/pc.	€/box	kg.
C 13 04 000	4			0,500
C 13 06 000	6			0,600
C 13 08 000	8			0,650
C 13 10 000	10			0,700

made by



Ganci in nylon «Colore nero»

Per applicazioni industriali.
Montaggio tramite nodo.

Nylon hooks «Black colour»

Knot fitting.

Articolo - Item	Foro Hole Ø mm.	€/pc.	€/box	kg.
C 26 04 000	4			0,500
C 26 06 000	6			0,600
C 26 08 000	8			0,650

made by



Ganci in nylon «Colore bianco»

Montaggio tramite nodo.

Nylon hooks «White colour»

Knot fitting.

Articolo - Item	Foro Hole Ø mm.	€/pc.	€/box	kg.
C 13 04 013	5			0,650

made by



Ganci in nylon

Montaggio tramite nodo.

Nylon hooks

Knot fitting.

Articolo - Item	Foro Hole Ø mm.	Colore Colour	€/pc.	€/box	kg.
C 26 04 015	5				0,650
C 13 04 015	5				0,650

made by



Ganci in nylon a moschettone «Colore bianco»

Montaggio tramite nodo.

Nylon hooks «White colour»

Knot fitting.

Articolo - Item	Foro Hole Ø mm.	pz.-pcs.	€/pc.	€/box	kg.
C 13 08 012	8	10			0,130
C 13 10 014	10	10			0,150

made by



Ganci a montaggio istantaneo fermatessuto

In materia plastica, per l' applicazione di teloni copribarca senza montaggio di occhielli.

Quick fitting hooks

Manufactured in plastic.
For the application of boat covers without eyelets.

Articolo - Item	telo - cloth mm.	€/pc.	€/box	kg.
O 11 00 002	0 > 2			
O 11 15 005	1,5 > 5			

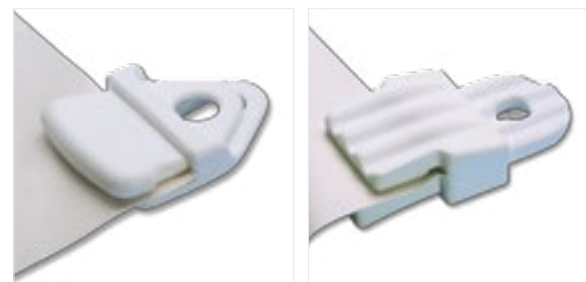

Ganci in nylon «Pratic»

Nylon hooks «Pratic»

Articolo - Item	Ø mm.	€/pc.	€/box	kg.
C 13 06 011	8			0,200



made by made by made by 

Gancio a moschettone a montaggio automatico indicato per corda elastica \varnothing 6 e 8 mm.

Fabbricato in nylon di colore nero e bianco. Gancio fissabile a scatto con un efficace sistema autobloccante.

Self-tailing snap hook for shock cord \varnothing 6 and 8 mm.

Made of black and white coloured nylon.

Articolo - Item	per corda elastica for shock cord \varnothing mm.	Colore Colour	pcs.	€/pc.	€/box	kg.
C 28 05 080	5-6	■	50			0,180
C 26 08 019	8	■	50			0,715
C 28 05 074	5-6	□	50			0,180
C 26 08 074	8	□	50			0,715

Terminali autobloccanti mod. «Olive Clips» per fissaggio corda elastica

Fabbricati in nylon ad alta resistenza.

«Olive Clips» for shock cord fastening

Made of high resistance nylon.

Articolo - Item	per corda elastica for shock cord \varnothing mm.	Colore Colour	pz.-pcs.	€/pc.	€/box	kg.
C 25 05 015	5	■	50			0,280
C 25 06 015	6	■	50			0,280
C 25 08 015	8	■	50			0,330



Gancio a montaggio automatico Self-tailing hook for rope

Articolo - Item	Colore Colour	per corda elastica for shock cord \varnothing mm.	€/set 6 pcs.	kg.
C 28 06 080	■	6		



Terminali fermacorda a molla

Realizzati in nylon.

Terminal caps for line

Made of nylon.

Articolo - Item	Colore Colour	Foro Hole \varnothing mm.	€/pc.	€/box	kg.
C 90 08 338	■	8			0,030

Terminali di fissaggio per copri barche

Fabbricati in nylon ad alta resistenza.

«Utility clip» fastening

Made of high resistance nylon.

Articolo - Item	per corda elastica for shock cord \varnothing mm.	pcs.	€/pc.	€/box	kg.
C 25 06 010	6	50			0,150
C 25 08 012	8	50			0,160

Gancio a moschettone «Colore nero»

Gancio fabbricato in nylon. Indicato per montaggio su scotte richiamo albero.

Hook «Black colour»

Hook made of nylon.

Articolo - Item	kg.	Foro Hole \varnothing mm.	pcs.	€/pc.	€/box	kg.
C 13 08 013	100	8	50			0,370

Gancio in nylon per tubo \varnothing 20mm e 25mm indicato per corda elastica \varnothing 8 mm.

Nylon hook for pipe \varnothing 20mm and 25mm suitable for \varnothing 8 mm. elastic rope

Articolo - Item	per tubo for hose \varnothing mm.	Colore Colour	pcs.	€/pc.	€/box	kg.
C 26 20 008	20	■	10			
C 26 25 008	25	■	10			
C 13 20 008	20	□	10			
C 13 25 008	25	□	10			



Gancio a S

Articolo - Item	€/pc.	€/box	kg.
H 10 08 000			0,420



Anelle a D

Articolo - Item	€/pc.	€/box	kg.
H 12 35 000			0,330



Gancio doppio e contropiastra

Double hook with plate

Articolo - Item	Tipo Type	€/pc.	€/box	kg.
H 10 32 065	A			0,740
H 10 32 030	B			0,065



Gancio grande

Hook

Articolo - Item	€/pc.	€/box	kg.
H 10 08 237			0,720



Gancio medio

Hook

Articolo - Item	€/pc.	€/box	kg.
H 10 08 239			0,550



Borchie a montaggio rapido in confezione «Self-service»

Plastic grommet «Self-service» packing

Fabbricate in plastica.

Made of plastic.

Articolo - Item	Foro - Hole Ø mm.	Colore Colour	€/pc.cartella 12 pz. Box of 12 pcs.	kg.
A 22 14 000	15	■		0,200
A 22 16 000	15	□		0,200
A 22 17 000	15	■		0,200



Borchie a montaggio rapido

Plastic grommet

Fabbricate in plastica.

Made of plastic.

Articolo - Item	Foro - Hole Ø mm.	Colore Colour	€/pc.	€/box	kg.
A 22 14 020	15	■			0,750
A 22 16 020	15	□			0,750
A 22 17 020	15	■			0,750



A



B



Ganci in nylon

Fissaggio mediante viti. Colore nero.

Nylon hooks

Fitting by screws. Black colour.

Articolo - Item	Tipo Type	€/pc.	€/box	kg.
A 21 00 020	A			0,240
C 29 00 080	B			0,270



Gancetto per telo copribarche

Realizzato in nylon.

Articolo - Item	Foro corda Rope hole Ø mm.	mm.	€/pc.	€/box	kg.
O 11 06 040	8	38x40			0,440



Hooks for boats cover application

Made of nylon.

Accessori per impiombare - Accessories for splicing

Nylon



Redance in nylon

Confezione in sacchetto.

Articolo - Item	Ø mm.	pz.-pcs.	€/pc.	€/box	kg.
M 11 05 000	5	10			* 0,020
M 11 06 000	6	10			0,030
M 11 08 000	8	10			0,050
M 11 10 000	10	10			0,050
M 11 12 000	12	10			0,090
M 11 14 000	14	10			0,150
M 11 16 000	16	10			0,210
M 11 19 000	19	10			0,310
M 11 20 000	20	10			0,450
M 11 24 000	24	10			0,750

Nylon thimbles

Packing in bag.

Stainless steel



Redance in acciaio inox

Confezione in sacchetto.

Articolo - Item	Ø mm.	pz.-pcs.	€/pc.	€/box	kg.
M 10 02 000	2	10			0,015
M 10 03 000	3	10			0,025
M 10 04 000	4	10			0,040
M 10 05 000	5	10			0,060
M 10 06 000	6	10			0,080
M 10 08 000	8	10			0,150
M 10 10 000	10	10			0,230
M 10 12 000	12	10			0,420
M 10 14 000	14	10			0,560
M 10 16 000	16	10			1,200
M 10 18 000	18	4			* 0,540
M 10 20 000	20	4			* 0,590

Stainless steel thimbles

Packing in bag.

Stainless steel

► Spessore maggiorato
► Increased thickness



Redance inox «Super Strong»

Articolo - Item	Ø mm.	€/pc.	kg.
M 10 26 000	26		
M 10 28 000	28		
M 10 30 000	30		
M 10 32 000	32		1,050

S.S. thimbles «Super Strong»



Pinza per fissaggio anellini

Indicata per chiudere gli anellini in ottone o in acciaio sulla corda elastica.

Crimping tool

Suitable for crimp clamps to shock cord.

Articolo - Item	€/pc.	kg.
C 08 00 240		0,250



Anelle in acciaio inox

Indispensabili per fissare la corda elastica all'estremità dei ganci.

Stainless steel clamp rings

For use with stainless steel and nylon hooks.



Articolo - Item	Per corda elastica Ø mm. For shock cord Ø mm.	€/pc.	€/box	kg.
C 09 04 002	4			0,200
C 09 06 003	6			0,300
C 09 08 005	8			0,500
C 09 10 006	10			0,800



Capicorda termorestringenti «Fast End» per cime e trecce

Capicorda termorestringenti per trecce.
Capicorda da 4 cm.

Terminal «Fast End» for braided and strand ropes

Available for Ø 6,5 to max. 12,5 mm. and from Ø 10 to max. 19 mm.

Articolo - Item	Ø mm.	€/La confezione 6 pz. €/Packing of 6 pcs.	kg.
L 54 12 004	da min. 6,5 a max. 12,5		0,060
L 54 19 004	da min. 10 a max. 19		0,120



* Disponibile su richiesta - Available on request

Bitte in nylon - Nylon cleats



Coppia di passacavi asimmetrici in nylon

Fabbricati in nylon di prima qualità. Particolarmente resistente. Fissaggio tramite vite. Colore nero.

Pair of black colour nylon fairleads

Made of strong nylon material. Fastening by screws. Black colour.

Articolo - Item	← mm.	Pollici Size"	€/Paio - Pair	€/box	kg.
N 39 02 120	120	60			0,100
N 39 02 150	150	140			0,150



Bitta a galloccia in nylon bianco

White colour open base cleat

Articolo - Item	← tot. mm.	Interasse fori Hole wheelbase mm.	€/pc.	€/box	kg.
N 31 00 060	60	20			0,050
N 31 00 080	80	21			0,070
N 31 00 110	110	30			0,120
N 31 00 145	140	38			0,250
N 31 00 180	165	41			0,500
N 31 00 198	200	48			0,750
N 31 00 210	225	52			0,800



Bitta a galloccia in nylon nero

Black colour open base cleat

Articolo - Item	← tot. mm.	Interasse fori Hole wheelbase mm.	€/pc.	€/box	kg.
N 32 00 060	60	20			0,050
N 32 00 080	80	21			0,070
N 32 00 110	110	30			0,120
N 32 00 145	140	38			0,250
N 32 00 180	165	41			0,500
N 32 00 198	200	48			0,750
N 32 00 210	225	52			0,800



Bitte a strozza in nylon «Nero»

Fabbricata in nylon di prima qualità. Particolarmente resistente. Fissaggio tramite due viti. Colore nero.

Black colour nylon jib sheet cleat

Made of strong nylon material. Fastening by screws. Black colour.

Articolo - Item	← mm.	Per scotte For sheets Ø mm.	€/pc.	€/box	kg.
N 31 01 150	150	8-16			0,750



Bitte inox - Stainless steel cleats

Bitta in acciaio inox modello «Hollow Cleat»

Realizzata in acciaio inox lucidato a specchio.

Stainless steel cleats mod. «Hollow Cleat»

Manufactured in mirror polished stainless steel.

Articolo - Item	← mm.	Pollici - Inch	pcs.	€/pc.	kg.
N 30 00 150	150	6"	50		0,150
N 30 00 200	200	8"	50		0,300
N 30 00 250	250	10"	4		0,440



**Acciaio inox
Stainless steel**

Basetta in plastica bianca per bitte «Hollow Cleat»

White plastic reinforcement base for «Hollow Cleat» cleat

Articolo - Item	← per bitte - for cleats mm.	Indicate per Suitable for	€/paio pair	€/box	kg.
N 30 45 150	150	6"	10		0,100
N 30 45 200	200	8"	10		0,100



Moschettone a pera in acciaio inox Aisi 316
Aisi 316 stainless steel snap-hook

Articolo - Item	mm.	Ø mm.	pcs.	kg.	€/pc.	€/box
M 05 04 040	40	4	10	0,120		
M 05 05 050	50	5	10	0,180		
M 05 06 060	60	6	10	0,350		
M 05 07 070	70	7	10	0,590		
M 05 08 080	80	8	10	0,750		
M 05 10 100	100	10	5	0,700		
M 05 12 120	120	11	1	0,200		
M 05 14 140	180	14	1	0,200		

Moschettone a pera con anello in acciaio inox Aisi 316
Aisi 316 stainless steel snap-hook with eye

Articolo - Item	mm.	Ø mm.	pcs.	kg.	€/pc.	€/box
M 04 05 050	50	5	10	0,200		
M 04 06 060	60	6	10	0,380		
M 04 07 070	70	7	10	0,600		
M 04 08 080	80	8	10	0,750		
M 04 10 100	100	10	5	0,700		

Moschettone a pera con arresto a vite in acciaio inox Aisi 316
Aisi 316 stainless steel snap-hooks with screw safety sleeve

Articolo - Item	mm.	Ø mm.	pcs.	kg.	€/pc.
M 06 10 100	100	10	1	0,100	

Moschettone con apertura a vite in acciaio inox Aisi 316
Snap-hooks with screw safety sleeve in AISI 316 stainless steel

Articolo - Item	mm.	Ø mm.	pcs.	kg.	€/pc.	€/box
M 03 08 054	75	8	10	0,600		

Moschettone con apertura trasversale in acciaio inox Aisi 316
Aisi 316 stainless steel snap-hook with side opening

Articolo - Item	mm.	Ø mm.	pcs.	kg.	€/pc.
M 05 00 080	80	8	1	0,100	
M 05 00 100	100	10	1	0,150	

Moschettone a pera in acciaio zincato
Galvanized steel snap-hook

Articolo - Item	mm.	Ø mm.	pcs.	kg.	€/pc.	€/box
M 32 05 050	50	5	10	0,150		
M 32 06 060	60	6	10	0,300		
M 32 07 070	70	7	10	0,500		
M 32 08 080	80	8	10	0,700		
M 32 10 100	100	10	10	1,300		



A



B



C

Tanica con particolare sistema di sfiato nel tappo

Realizzata in polietilene robusto anticorrosione e antirottura.

Portable fuel tanks

Manufactured in high resistant polyethylene.

Articolo - Item	Mod.	Lt.	€/pc.	kg.
N 01 07 081	A - Benzina-Fuel	5		0,510
N 01 07 079	A - Benzina-Fuel	10		0,840
N 01 06 402	A - Benzina-Fuel	20		1,320
N 01 07 539	A - Benzina-Fuel	25		1,600
N 01 03 711	B - Diesel-Gasoline	20		1,630
N 01 03 629	C - Imbuto-Spout kit 4 pcs.	-		0,080

Serbatoi - Fuel tanks



Canestri in plastica per carburante

Completo di bocchettone flessibile. Fabbricati in plastica, colore rosso.

Jerrycan for fuel

Complete with flexible spout. Made in plastic, red colour.

Articolo - Item	Lt.	pcs.	€/pc.	kg.
N 01 05 082	5	10		
N 01 10 082	10	6		
N 01 22 082	20	4		
N 01 00 035	Tappo di ricambio Spare plug	1		



Canestri in plastica completi di indicatore carburante

Completi di bocchettone flessibile. Fabbricati in plastica, colore rosso.

Jerrycan for fuel with level indicator

With flexible spout. Made in plastic, red colour.

Articolo - Item	Lt.	pcs.	€/pc.	kg.
N 01 05 024	5 - con indicatore livello with level indicator	6		
N 01 10 024	10 - con indicatore livello with level indicator	6		



Taniche in plastica con sistema brevettato di rabbocco benzina

EAP & AS/NZS 2906:2001 Standards

Plastic auto shut off fuel cans

EAP & AS/NZS 2906:2001 Standards

Articolo - Item	Lt.	Lunghezza Lenght	Larghezza Width	Altezza Height	€/pc.	kg.
N 01 05 182	5	260	130	275		0,800
N 01 10 182	10	290	160	346		1,300
N 01 20 182	20	330	190	476		1,800

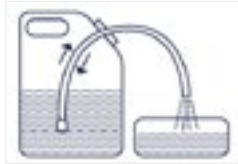

Strumenti travaso - Tools for pouring

made by **TREM****Tubo con terminale auto-svuotante**
«Easy Pouring»**Pipe with self-draining terminal**
«Easy Pouring»

Articolo - Item	←→ mt.	Ø mm.	€/kit	kg.
N 01 16 015	2	19		0,400
N 01 25 018	1,8	25		

**Imbuto per travaso carburante**
con prolunga incorporata**Funnel with built-in**
extensionCompleto di prolunga flessibile.
In materia plastica con filtro.Manufactured in plastic material.
With filter.

Articolo - Item	Ø bocca opening mm.	€/pc.	kg.
N 01 02 415	150		0,180

Ghiacciaie portatili - Ice boxes



A



B



C

**Ghiacciaie portatili**

Costruite per l'uso a bordo, ideali per conservare alimenti pescati o come vasche per contenere esche vive. Realizzate in Abs resistente agli urti e ai raggi UV. Interno in materiale plastico inodore. Possono essere utilizzate anche come sedute.

Icebox and seat

Suitable for storage of fish or living bait. Made of shockproof and UV resistant Abs. Inside made of odourless plastic material. Can be used as a seat.

Articolo - Item	Tipo - Type	Capacità Capacity lt.	Modello - Model	↑ mm.	Durata freddo ore Cold length hours	kg.	€/pc.
D 43 36 000	A	36	-	500 x 305 x 408	72	3,200	
D 43 52 000	B	52	-	660 x 345 x 430	72	4,000	
P 00 20 033	C	20	pieghevole - folding	330 x Ø 300	-	0,630	

Cestino - Trolley

made by **TREM****Cestino-Trolley doppio uso**

Adatto per bicicletta e ideale come contenitore per la spesa.

Multi basket trolley

Suitable for use on bicycle and as a shopping basket.

Articolo - Item	Colore - Colour	↑ cm.	kg.	€/pc.
O 00 40 080	Nero - Black	40 x 32 x 29	1,000	

Prima di essere utilizzate, le bici acquistate devono essere da Voi registrate
Before using the bikes bought from you, must be registered

CAMBIO SHIMANO 6 MARCE
SHIMANO GEARS 6 SPEEDS
RUOTE-WHEELS 16"



SPECIAL BIKE



Bici pieghevole con cambio

Folding bicycle with gears

Realizzata in acciaio verniciato.
Sella in poliuretano.
Provvista di ruote da 16".
Cambio Shimano a 6 marce.

Manufactured in painted steel.
Polyurethane saddle.
Provided with 16" wheels.
Shimano gears with 6 speeds.

Articolo - Item	Mod.	Colore - Colour	↕ cm.	📦 kg.	€/pc.
O 00 16 013	Bici-Bike	Nero-black	73 x 30 x 43	13,000	

Prima di essere utilizzate, le bici acquistate devono essere da Voi registrate
Before using the bikes bought from you, must be registered

SPECIAL BIKE

CAMBIO SHIMANO 6 MARCE
SHIMANO GEARS 6 SPEEDS
RUOTE-WHEELS 20"



Bici pieghevole

Folding bicycle

Realizzata in acciaio verniciato.
Sella in poliuretano.
Provvista di ruote da 20".
Parafanghi in plastica.

Manufactured in painted steel.
Polyurethane saddle.
Provided with 20" wheels.
Plastic fenders.

Articolo - Item	Mod.	Colore - Colour	↕ cm.	📦 kg.	€/pc.
O 00 20 006	Bici-Bike	Nero-black	73 x 30 x 43	13,000	



Sacca portabici

Bike/holder bag

Articolo - Item	Colore - Colour	↕ mm.	📦 kg.	€/pc.
O 00 80 013	Nero-Black		0,300	



**Supporto bicchieri a ribalta**

In plastica.
Confezione singola.

Glass can holder

Pastic material.
Single packing.

Articolo - Article	Colore - Colour	€/pc.
D 17 74 004	Bianco - White	

**Sottobicchiere in gomma anti-scivolo**

Rivestimento del piede del bicchiere per flute e bicchieri da vino.
Assortimento in diversi colori
Confezione da 6 pezzi.

Rubber anti-slip mat for glasses

Glass foot coating for flutes and wine glasses. Stock in different colours.

Packing in polybag of 6pcs.

Articolo - Article	€/Set 6 pcs.
D 27 92 999	

Carrello portatutto - Folding trolley**Carrello pieghevole mod. «Kanguro Plus»**

Ruote in plastica per sabbia.

Folding trolley mod. «Kanguro Plus»

Plastic wheels for sand.

Articolo - Item	↳ aperto - open mm.	↳ chiuso - closed mm.	€/pc.	kg.
O 00 50 130	130 x 50 x 120 H.	23 x 50 x 78 H.		

Sacche impermeabili - Waterproof bags

Sacche stagne T-BAG:
mantengono tutto asciutto!

T-BAG waterproof bags:
everything stays dry!

Tbag



100% impermeabili - waterproof



A



B



C



Sacche impermeabili

Waterproof bags

Articolo - Item	Tipo Type	Modello - Model	Colore Colour		Materiale - Material	Litri Litres	↑ mm.	€/pc.	kg.
B 06 20 009	A	senza cinghia-w/out belt		Giallo-Yellow	PVC	18	52 x Ø 20		0,160
B 06 40 010	A	senza cinghia-w/out belt		Giallo-Yellow	PVC	37	55 x Ø 29		0,250
B 06 60 011	A	senza cinghia-w/out belt		Giallo-Yellow	PVC	46	68 x Ø 29		0,530
B 07 70 011	B	senza cinghia-w/out belt		Arancio-Orange	Nylon 420D TPU	46	68 x Ø 29		0,420
B 07 79 011	C	senza cinghia-w/out belt		Grigio-Grey	Nylon 420D TPU	46	68 x Ø 29		0,580
B 07 79 108	C	con cinghia-with belt		Grigio-Grey	Nylon 420D TPU	5	44 x Ø 12		0,100
B 07 79 109	C	con cinghia-with belt		Grigio-Grey	Nylon 420D TPU	18	52 x Ø 20		0,130
B 07 79 110	C	con cinghia-with belt		Grigio-Grey	Nylon 420D TPU	37	55 x Ø 29		0,200



Contentore waterproof per Ipad Waterproof case for Ipad

Articolo - Item	↑ mm.	Colore Colour	€/pc.	kg.
D 10 82 805	4 x 210 x 290			0,110



Contentore waterproof per Iphone Waterproof case for Iphone

Articolo - Item	↑ mm.	Colore Colour	€/pc.	kg.
D 10 82 803	3 x 85 x 170			0,040



Contentore waterproof per macchina fotografica Waterproof case for digital camera

Articolo - Item	↑ mm.	€/pc.	kg.
D 10 82 807	3 x 120 x 180		0,050



ESPOSITORE ACCESSORI PER IL CAMPING

ART. Z0500000 COMPLETO DI 370 CONFEZIONI E 58 MODELLI

ACCESSORI VARI - MISCELLANEOUS ACCESSORIES

Confezione SELF-SERVICE
per guadagnare tempo
e aumentare le vostre vendite



Espositore accessori camping vuoto **Stand for camping accessories (empty)**

Completo di ganci per bister.

With hooks for blister display.

Articolo	cm.	€/pc.
Z 05 00 001	190 x 70	

**Art. Z 05 00 000 ESPOSITORE COMPLETO DI 285 CONFEZIONI E 42 PRODOTTI DIVERSI
STANDER COMPLETE WITH 285 PACKINGS AND 42 DIFFERENT ITEMS**

€/pc.

Articolo	Descrizione	pz.	€	€/totale	Articolo	Descrizione	pz.	€	€/totale
Z 15 00 360	Tenditore in gomma	6	10		H 06 23 095	Picchetto Golia 24cm.	6	5	
Z 15 00 280	Tenditore in gomma	6	10		H 06 30 125	Picchetto Golia 30cm.	6	5	
Z 15 00 095	Elastico in tensione	6	5		H 06 24 360	Picchetto Standard 24cm.	12	5	
Z 15 00 106	Tenditore in gomma	6	10		H 01 25 070	Picchetto Ercules 25cm.	6	5	
T 10 06 020	Treccia Ø6 x 20m.	6			H 01 30 090	Picchetto Ercules 30cm.	6	5	
T 10 08 015	Treccia Ø8 x 15m.	6			H 00 25 330	Picchetto Export 25cm.	6	5	
T 10 10 011	Treccia Ø10 x 10m.	6			H 00 30 500	Picchetto Export 30cm.	6	5	
T 39 02 050	Treccia in poliestere Ø2,0	6			H 04 25 420	Picchetto Ciclope 25cm.	6	5	
T 39 03 050	Treccia in poliestere Ø3,0	6			H 07 20 180	Spillone a chiodo 20cm.	6	10	
T 39 04 040	Treccia in poliestere Ø4,0	6			H 07 20 210	Picchetto per stuoia	6	10	
T 39 05 030	Treccia in poliestere Ø5,0	6			Z 09 00 380	Martello gigante	5		
T 10 04 020	Treccia per tenditori Ø4,0	5			N 01 20 002	Ghirba pieghevole in PVC	3		
Z 40 40 150	Tenditore per tenda	4	10		N 01 20 300	Ghirba solare	3		
Z 43 06 072	Tenditore elastici	6	5		Z 18 08 026	Spazzolino WC con custodia	2		
H 11 20 250	Fascette stringitubo	6	10		Z 18 14 031	Portarifiuti	5		
A 22 16 000	Borchie colore bianco	12	6		Z 18 00 100	Carta igienica	6	6	
H 11 00 330	Clips con asola Ø20/25	6	10		C 31 25 150	Cinghia Fast Cargo 150cm.	6		
H 24 22 066	Base per paletti	6	10		C 31 25 250	Cinghia Fast Cargo 250cm.	6		
Z 15 00 622	Clips giunzione paletti	6	10		D 17 64 090	Porta bicchiere a molla	6	6	
Z 15 17 626	Clips giunzione paletti	6	10						
Z 15 20 156	Clips giunzione paletti	6	10						
H 24 18 006	Tappo puntale corto	6	10						
H 24 22 006	Tappo puntale corto	6	10						

ACCESSORI VARI - MISCELLANEOUS ACCESSORIES

ARTICOLI IN STOCK - STOCK ITEMS

PORTABICI "TROTTER LIFT" 60 cm.
"TROTTER LIFT" CYCLE HOLDER 60cm.



art. O 06 00 620 - € 199,00 NETTO

LAVANDINO TONDO IN CERAMICA
TILED ROUND SINK



art. Z 08 10 051 - € 60,00 NETTO

GRADINO PIEGHEVOLE
FOLDING STEP



art. Z 36 01 095 - € 10,50 NETTO

SERRATURA IN OTTONE CROMATO
LOCK IN CHROMED BRASS



art. M 35 50 096 - € 10,00 NETTO

MOLLA A GAS
GAS SPRING



art. M 37 20 500 - € 4,00 NETTO

ASTE PER VERANDE
POLES FOR VERANDAS



art. V 06 00 150 - € 7,00 NETTO

INVERTER 1200W 24V.
1200W 24V. INVERTER



art. L 06 24 315 - € 60,00 NETTO

CERNIERA INOX
HINGE IN S. STEEL



art. M 35 77 068 - € 3,50 NETTO

PORTABICI "MC-LOUIS" 80 cm.
"MC-LOUIS" CYCLE-HOLDER 80 cm.



art. O 12 03 996 - € 76,00 NETTO

A		C1006050.....123	D1042033.....103	F2380100.....124	L0612008.....93	L2910050.....107	
A0810350.....120	C1008050.....123	D1074370.....49	D1082803.....139	G		L3125200.....20	
A1108040.....120	C1010050.....123	D1082805.....139	D1082807.....139	G3135023.....14	L0612300.....90	L4306023.....79	
A1108060.....120	C1012050.....123	D1082807.....139	D1084054.....51	G3135023.....17	L0612502.....73	L4309028.....79	
A1108080.....120	C1014050.....123	D1082807.....139	D1312018.....39	H		L4310039B.....79	
A1108100.....120	C1016050.....123	D1084054.....51	D1605002.....105	H0025050.....112	L0612600.....91	L4310044B.....79	
A1108120.....120	C1018050.....123	D1312018.....39	D1605003.....105	H0025330.....112	L0613065.....89	L4312030.....79	
A1108150.....120	C1020050.....123	D1605002.....105	D1700155.....53	H0030078.....112	L0613066.....89	L4400156.....79	
A1108200.....120	C1025020.....110	D1605003.....105	D1700170.....53	H0030500.....112	L0622100.....91	L4400158.....77	
A1110080.....120	C1304000.....129	D1700155.....53	D1760030.....53	H0125070.....112	L0622150.....91	L4400200.....79	
A1110100.....120	C1304013.....129	D1700170.....53	D1760060.....53	H0130090.....112	L0622200.....91	L4400215.....79	
A1110150.....120	C1304015.....129	D1760030.....53	D1760070.....53	H025070.....112	L0624315.....142	L4400252.....74	
A1110200.....120	C1306000.....129	D1760060.....53	D1764090.....106	H0425420.....112	L0630150.....91	L4400253.....74	
A1308080.....119	C1306011.....129	D1764090.....106	D1770074.....53	H0430090.....112	L0640200.....91	L4400550.....76	
A1804080.....122	C1308000.....129	D1770074.....53	D1770079.....53	H0618300.....113	L0674435.....92	L4400553.....75	
A1806074.....122	C1308012.....129	D1770079.....53	D1774004.....138	H0623000.....113	L0674516.....92	L4400553.....77	
A1806075.....122	C1308013.....130	D1774004.....138	D1774060.....53	H0623095.....113	L0680295.....90	L4400926.....77	
A1806080.....122	C1310000.....129	D1774060.....53	D1774070.....53	H0624030.....113	L0808012.....78	L4400939.....77	
A1806082.....122	C1310014.....129	D1774070.....53	D1774110.....53	H0624360.....113	L0808024.....78	L4400943.....77	
A1806085.....122	C1320008.....130	D1774110.....53	D1774155.....53	H0630000.....113	L0810012.....78	L4401557.....76	
A1808074.....122	C1325008.....130	D1774155.....53	D1774170.....53	H0630035.....113	L0810024.....78	L4402768.....75	
A1808075.....122	C1414150.....121	D1774170.....53	D2792999.....138	H0630125.....113	L0810041.....78	L4402769.....75	
A1808077.....122	C1414250.....121	D2792999.....138	D3920020.....28	H0720030.....113	L0812010.....78	L4400623.....79	
A1808079.....122	C1525300.....119	D3920020.....28	D3934038.....39	H0720180.....113	L0815012.....78	L4408060.....76	
A1808082.....122	C1525450.....119	D3934038.....39	D3950050.....28	H0720210.....113	L0815024.....78	L4409028.....79	
A1808085.....122	C1525600.....119	D3950050.....28	D4336000.....136	H1001396.....94	L0824010.....78	L4409280.....76	
A1808087.....122	C1906081.....122	D4336000.....136	D4352000.....136	H1003396.....94	L1500020.....89	L4410031B.....79	
A1808088.....122	C1908081.....122	E		H1008000.....131	L1500025.....89	L4410039B.....79	
A1810075.....122	C2103020.....124	E0001008.....39	E0013020.....39	H1008237.....131	L1501341.....86	L4410044B.....79	
A1810082.....122	C2505015.....130	E0013020.....39	E0390211.....115	H1008239.....131	L1507200.....86	L4410285.....74	
A1810085.....122	C2506010.....130	E0390211.....115	E0390301.....115	H1032030.....131	L1521341.....86	L4410608.....75	
A2000200.....128	C2506015.....130	E0390301.....115	E0500150.....115	H1032065.....131	L1579542.....86	L4412022.....74	
A2000250.....128	C2508012.....130	E0500150.....115	E0541370.....115	H1100012.....110	L1580016.....89	L4412030.....79	
A2006160.....128	C2508015.....130	E0541370.....115	E0800600.....116	H1100055.....110	L1580025.....89	L4412156.....79	
A2100020.....50	C2604000.....129	E0800600.....116	E3515095.....105	H1120250.....110	L1580035.....89	L4412939.....77	
A2100020.....50	C2604015.....129	E3515095.....105	E3515095.....105	H1235000.....131	L1580050.....89	L4420200.....79	
A2100020.....116	C2606000.....129	E3519080.....105	E3577150.....105	H2001210.....111	L1580070.....89	L4420215.....79	
A2100020.....131	C2608000.....129	E3577150.....105	E3582300.....105	H2101215.....111	L1582010.....89	L4420290.....76	
A2214000.....116	C2608019.....128	E3582300.....105	E3774221.....104	H2101250.....111	L1582025.....89	L4424666.....74	
A2214000.....131	C2608019.....130	E3774221.....104	E3774252.....104	H2301215.....111	L1582035.....89	L4474165.....77	
A2214020.....116	C2608074.....130	E3774252.....104	E4000200.....104	H2301700.....111	L1582050.....89	L4474166.....77	
A2214020.....131	C2620008.....130	E4000200.....104	E4000400.....104	H2408007.....110	L1582070.....89	L4474263.....75	
A2216000.....116	C2625008.....130	E4000400.....104	E4352009.....116	H2410007.....110	L1586542.....86	L4474264.....75	
A2216020.....116	C2805074.....128	E4352009.....116	E4652009.....116	H2416000.....110	L1977002.....95	L4474926.....77	
A2216020.....131	C2805074.....130	E4652009.....116	E4674050.....105	H2422000.....110	L2000021.....95	L4474951.....74	
A2217000.....116	C2805080.....128	E4674050.....105	E4679050.....105	H2422060.....110	L2001649.....95	L4474951.....76	
A2217000.....131	C2805080.....130	E4679050.....105	E4852009.....116	L2003007.....86	L2003007.....86	L5412004.....132	
A2217020.....116	C2806080.....130	E4852009.....116	E4952009.....116	L2006000.....86	L2006000.....86	L5419004.....132	
A2217020.....131	C2900080.....116	E4952009.....116	E6000020.....68	L2200323.....95	L2200323.....95	L6400601.....94	
A3108060.....121	C2900080.....131	E6000020.....68	E6000032.....68	L2216110.....96	L2216110.....96	L6402490.....73	
A3108100.....121	C3125150.....119	E6000032.....68	E6000051.....68	L2230105.....96	L2230105.....96	L6412063.....94	
A3508083.....121	C3125250.....119	E6000051.....68	E6000070.....68	L2235067.....95	L2235067.....95	L6412156.....73	
A3508103.....121	C3125400.....119	E6000070.....68	E6000089.....68	L2250160.....96	L2250160.....96	L6412180.....73	
A3508153.....121	C3515045.....26	E6000089.....68	E6000108.....68	L2273099.....96	L2273099.....96	M	
B		E6000108.....68	E6000127.....68	L2300049.....38	L2300049.....38	M0308054.....134	
B0620009.....139	C3515046.....26	E6000127.....68	E6000140.....68	L2300050.....38	L2300050.....38	M0405050.....134	
B0640010.....139	C3515047.....26	E6000140.....68	E6000156.....68	L2300300.....37	L2300300.....37	M0406060.....134	
B0660011.....139	C3550750.....41	E6000156.....68	E6000184.....68	L2300301.....37	L2300301.....37	M0407070.....134	
B0770011.....139	C3580030.....26	E6000184.....68	E6000227.....68	L2300400.....37	L2300400.....37	M0408080.....134	
B0779011.....139	C7504000.....123	E6000227.....68	E6006007.....68	L2300500.....37	L2300500.....37	M0410100.....134	
B0779108.....139	C7505000.....123	E6006007.....68	E6006009.....68	L2304700.....36	L2304700.....36	M0500080.....134	
B0779109.....139	C7506000.....123	E6006009.....68	E6006011.....68	L2304800.....36	L2304800.....36	M0500100.....134	
B0779110.....139	C7704000.....123	E6006011.....68	F0100024.....128	L2304900.....36	L2304900.....36	M0504040.....134	
B0779119.....139	C7705000.....123	F0100024.....128	F0100060.....128	L2306228.....36	L2306228.....36	M0505050.....134	
B2870319.....39	C7706000.....123	F0100060.....128	F0200110.....128	L2307300.....38	L2307300.....38	M0506060.....134	
C		C7804000.....123	F0279803.....128	L2307301.....38	L2307301.....38	M0507070.....134	
C0004020.....123	C7805000.....123	C7805000.....123	F0300011.....128	L2308502.....38	L2308502.....38	M0507070.....134	
C0004030.....123	C7806000.....123	C7806000.....123	F0300110.....128	L2308600.....36	L2308600.....36	M0508080.....134	
C0006030.....123	C8003000.....123	C8003000.....123	F0379102.....128	L2308601.....36	L2308601.....36	M0510100.....134	
C0008050.....123	C8004000.....123	C8004000.....123	F2301050.....124	L2309801.....36	L2309801.....36	M0512120.....134	
C0010100.....123	C8005000.....123	C8005000.....123	F2305100.....124	L2310302.....36	L2310302.....36	M0514140.....134	
C00705055.....28	C8006000.....123	C8006000.....123	F2315035.....124	L2311100.....38	L2311100.....38	M0610100.....134	
C0800240.....132	C8008000.....123	C8008000.....123	F2375100.....124	L2312400.....38	L2312400.....38	M1002000.....132	
C0904002.....132	C9008338.....130	D		L2315000.....38	L2315000.....38	M1003000.....132	
C0906003.....132	D1006039.....51	D1006039.....51	F0300011.....128	L2322503.....38	L2322503.....38	M1004000.....132	
C0908005.....132	D1011084.....51	D1011084.....51	F0379102.....128	L2328002.....94	L2328002.....94	M1005000.....132	
C0910006.....132	D1018370.....49	D1018370.....49	F2301050.....124	L2395057.....94	L2395057.....94	M1006000.....132	
C1004050.....123	D1030037.....51	D1030037.....51	F2305100.....124	L2503017.....107	L2503017.....107	M1008000.....132	
C1005050.....123			F2315035.....124	L2535135.....107	L2535135.....107	M1010000.....132	
			F2375100.....124			M1012000.....132	

O1090220..... 45
 O1100002..... 129
 O1106040..... 131
 O1115005..... 129
 O1202405GR..... 22
 O1203403GR..... 22
 O1203996..... 142
 O1432720..... 52
 O1502215..... 25
 O3011246..... 18
 O3013160..... 19
 O3025003..... 20
 O3031257..... 18
 O3031285..... 18
 O3050022..... 20
 O3060427..... 86
 O3125003..... 15
 O3390090..... 29
 O3390095..... 29
 O4013023..... 117
 O4013033..... 117
 O4013034..... 117
 O4013036..... 117
 O4013044..... 117
 O4013045..... 117
 O4013048..... 117
 O4013057..... 117
 O4013068..... 117
 O4020037..... 117
 O4020045..... 117
 O4020048..... 117
 O4020049..... 117
 O4020057..... 117
 O4020068..... 117
 O4020106..... 117
 O4020128..... 117
 O4113023..... 117
 O4113033..... 117
 O4113034..... 117
 O4113036..... 117
 O4113044..... 117
 O4113045..... 117
 O4113048..... 117
 O4113057..... 117
 O4113068..... 117

P

P0010000..... 102
 P0020033..... 136
 P0023000..... 102
 P0024225..... 102
 P0025000..... 102
 P0032000..... 102
 P0033000..... 102
 P0208035..... 61
 P0212010..... 61
 P0212015..... 61
 P0212052..... 61
 P1612011..... 63
 P1612030..... 63
 P1612040..... 63
 P1612220..... 62
 P1620035..... 62
 P1620040..... 62
 P1620045..... 62
 P1620916..... 62
 P1624044..... 63
 P1624344..... 62
 P1638022..... 62
 P1644050..... 62
 P2135074..... 71
 P2135080..... 71

R

R0912018..... 98
 R3802166..... 99
 R3803381..... 99
 R3819400..... 99
 R3820066..... 100
 R3832440..... 99

S

S1415150..... 13
 S2004065..... 15
 S2025060..... 15
 S2025721..... 14
 S2035020..... 14
 S2035020..... 17
 S2035050..... 20
 S2035130..... 17
 S2035150..... 17
 S2041630..... 17
 S3007060..... 15
 S3026145..... 13
 S3026148..... 13
 S3026160..... 18
 S3026166..... 18
 S3035120..... 12
 S3035142..... 12
 S3035145S..... 12
 S3035155..... 12
 S3041975..... 19
 S3060566..... 19
 S4125005..... 15
 S4128005..... 15
 S4128006..... 15
 S4240627..... 15
 S4305160..... 13
 S4505128..... 13
 S4600007..... 16
 S4604108..... 12
 S4604148..... 12
 S4604149..... 12
 S4605126..... 13
 S4605138..... 13
 S4605164..... 12
 S4605165..... 12
 S5600009..... 16

T

T0403000..... 126
 T0404000..... 126
 T0405000..... 126
 T0602000..... 126
 T0603000..... 126
 T0604000..... 126
 T0615000..... 126
 T0625000..... 126
 T0905001R..... 126
 T0905180R..... 126
 T0906001R..... 126
 T0906180R..... 126
 T0908001R..... 126
 T0908180R..... 126
 T0910001R..... 126
 T0910180R..... 126
 T0912001R..... 126
 T0912180R..... 126
 T0914001R..... 126
 T0914180R..... 126
 T0916001R..... 126
 T0916180R..... 126
 T1004000..... 124
 T1004010..... 126
 T1004020..... 124
 T1005000..... 124
 T1006000..... 124
 T1006010..... 126
 T1006020..... 124
 T1008000..... 124
 T1008010..... 126
 T1008015..... 124
 T1010010..... 126
 T1010011..... 124
 T1012010..... 126
 T1500000..... 125
 T3101018..... 27
 T3102032..... 27
 T3103045..... 27
 T3104057..... 27

T3126270GR..... 27
 T3140370GR..... 27
 T3150470GR..... 27
 T3802030..... 125
 T3802200..... 125
 T3803000..... 125
 T3803020..... 125
 T3902050..... 124
 T3903050..... 124
 T3904040..... 124
 T3905030..... 124
 T3925050..... 124
 T5006000..... 127
 T5008000..... 127
 T5010000..... 127
 T5012000..... 127
 T5014000..... 127
 T5016000..... 127
 T5018000..... 127
 T5020000..... 127
 T5022000..... 127
 T5024000..... 127
 T5026000..... 127
 T5028000..... 127
 T5030000..... 127
 T5032000..... 127
 T5106075..... 127
 T5108075..... 127
 T5110000..... 127
 T5110075..... 127
 T5112000..... 127
 T5112075..... 127
 T5114000..... 127
 T5114075..... 127
 T5116000..... 127
 T5116075..... 127
 T5118000..... 127
 T5118075..... 127
 T5120000..... 127
 T5120075..... 127
 T5122075..... 127
 T5124000..... 127
 T5124075..... 127
 T5126000..... 127
 T5126075..... 127
 T5128000..... 127
 T5128075..... 127
 T5130000..... 127
 T5132000..... 127
 T5208000..... 127
 T5210000..... 127
 T5214000..... 127
 T5216000..... 127
 T5218000..... 127
 T5220000..... 127
 T5224000..... 127
 T5226000..... 127
 T5228000..... 127
 T5230000..... 127
 T5232000..... 127
 T7500000..... 125
 T7503000..... 125
 T7503020..... 125
 T7504000..... 125
 T7504013..... 125
 T7603000..... 125
 T7603020..... 125
 T7604000..... 125
 T7604013..... 125
 T7625022..... 125
 T7803000..... 125
 T7803020..... 125
 T7804000..... 125
 T7825022..... 125
 T8203000..... 125
 T8204000..... 125
 T8204013..... 125
 T8225022..... 125

T9402000..... 125
 T9402030..... 125
 T9403000..... 125
 T9403020..... 125
 T9502000..... 125
 T9502030..... 125
 T9503000..... 125
 T9503020..... 125
 T9602000..... 125
 T9603000..... 125
 T9603020..... 125
 T9702000..... 125
 T9703000..... 125
 T9703020..... 125

V

V0600150..... 142
 V1202407N..... 27
 V2537970..... 33
 V2540360..... 33
 V2550450..... 33
 V2558130..... 33
 V2560500..... 33
 V2565550..... 33
 V2574045..... 33
 V2578680..... 33

Z

Z0000150..... 50
 Z0000200..... 50
 Z0000220..... 13
 Z0000280..... 50
 Z0000390..... 106
 Z0018370..... 49
 Z0074115..... 49
 Z0074370..... 49
 Z0080040..... 50
 Z0080114..... 50
 Z0080115..... 49
 Z0500000..... 141
 Z0500001..... 140
 Z0600130..... 107
 Z0602700..... 109
 Z0604200..... 107
 Z0618544..... 107
 Z0620006..... 108
 Z0620007..... 108
 Z0620040..... 108
 Z0620050..... 108
 Z0620700..... 108
 Z0621015..... 108
 Z0630004..... 109
 Z0630008..... 109
 Z0630021..... 108
 Z0630022..... 108
 Z0630037..... 109
 Z0630038..... 109
 Z0630200..... 109
 Z0630700..... 109
 Z0670003..... 108
 Z0670005..... 108
 Z0810051..... 142
 Z0815300..... 67
 Z0820090..... 67
 Z0824375..... 67
 Z0825200..... 47
 Z0829000..... 67
 Z0830000..... 67
 Z0830238..... 67
 Z0830330..... 67
 Z0832026..... 67
 Z0832030..... 67
 Z0891913..... 97
 Z0900380..... 113
 Z1400024..... 116
 Z1500095..... 114
 Z1500106..... 114
 Z1500280..... 114
 Z1500360..... 114
 Z1504100..... 114

Z1800100..... 101
 Z1800436..... 101
 Z1801000..... 101
 Z1802510..... 101
 Z1804000..... 101
 Z1808026..... 100
 Z1813150..... 101
 Z1814031..... 100
 Z1866027..... 101
 Z2000010..... 80
 Z2000025..... 80
 Z2000237..... 85
 Z2000450..... 86
 Z2001000..... 81
 Z2001005..... 81
 Z2001013..... 46
 Z2001013..... 82
 Z2001090..... 80
 Z2001090..... 98
 Z2001100..... 81
 Z2001105..... 81
 Z2001205..... 81
 Z2002000..... 81
 Z2002090..... 80
 Z2002090..... 98
 Z2003015..... 80
 Z2004217..... 46
 Z2004217..... 82
 Z2005092..... 80
 Z2005197..... 46
 Z2005197..... 82
 Z2007013..... 46
 Z2007013..... 82
 Z2008180..... 80
 Z2008270..... 80
 Z2012013..... 46
 Z2012013..... 82
 Z2012286..... 83
 Z2013007..... 46
 Z2013007..... 82
 Z2020079..... 85
 Z2020086..... 85
 Z2021086..... 85
 Z2022079..... 84
 Z2022086..... 84
 Z2023086..... 85
 Z2024086..... 85
 Z2025079..... 85
 Z2025086..... 85
 Z2026086..... 85
 Z2027086..... 85
 Z2028079..... 85
 Z2031079..... 85
 Z2033079..... 84
 Z2034079..... 84
 Z2040403..... 46
 Z2040403..... 82
 Z2045750..... 84
 Z2046503..... 80
 Z2050034..... 84
 Z2075086..... 83
 Z2079012..... 83
 Z2079060..... 84
 Z2079075..... 83
 Z2079086..... 84
 Z2079120..... 83
 Z2079121..... 83
 Z2079160..... 84
 Z2081012..... 93
 Z2082018..... 80
 Z2082022..... 80
 Z2082024..... 80
 Z2082030..... 81
 Z2082035..... 80
 Z2082043..... 80
 Z2082181..... 80
 Z2086060..... 84
 Z2086086..... 84
 Z2086095..... 83
 Z2086120..... 83

Z2086121..... 83
 Z2086160..... 84
 Z2086230..... 83
 Z2086275..... 83
 Z2095079..... 83
 Z2095086..... 83
 Z2115046..... 35
 Z2120053..... 45
 Z2122048..... 35
 Z2180053..... 45
 Z2204003..... 33
 Z2212115..... 33
 Z2222002..... 32
 Z2223026..... 33
 Z2223028..... 33
 Z2223081..... 32
 Z2233118..... 32
 Z2233206..... 32
 Z2240045..... 33
 Z2254057..... 33
 Z2274118..... 32
 Z2274206..... 32
 Z2279118..... 32
 Z2279206..... 32
 Z2280118..... 32
 Z2280206..... 32
 Z2287093..... 33
 Z3600000..... 34
 Z3600235..... 35
 Z3601095..... 142
 Z3660826..... 34
 Z3679140..... 34
 Z3679235..... 35
 Z3906105..... 106
 Z4040150..... 114
 Z4300165..... 31
 Z4306072..... 114

NUM.

OP1842049..... 19
 OS2079061..... 17
 OS2079061..... 19
 OS3200222..... 15
 450035250..... 17
 450785578..... 27
 451830110..... 19
 451841611..... 14
 451841631..... 17
 451841817..... 14
 451842047..... 14
 451842047..... 19
 451842050..... 14
 451842050..... 19
 451842053..... 19
 451850007..... 20
 451850250..... 14
 451860204..... 19
 451860410..... 15
 451870102..... 26
 451880102..... 26
 454135000..... 14
 454379025..... 14
 454379025..... 15
 456203600..... 28
 457430110..... 19

A			Culle portabici	26	Martinetti	35	
Accessori gas	36 - 38		Cunei di stazionamento	45	Miscelatori	64-66	
Accessori per carrelli	42-44	D			Molla con nottolino e morsetti per paletti	110	
Accessori tende	110	Deviatori-staccabatteria	88	Doccette e contenitori	57-58	Molle a gas e supporti per molle	54-56
Adattatore rubinetti di collegamento	60	Doccia solare	60/106	E			
Adesivi	105	E		Elastici tende	114		
Aeratori	32	Espositore bobinette treccia	125	Espositore accessori camping	140-141		
Alzapagliolo	30	Espositore gradini plastica	34-35	Estintori	39		
Amaca portaoggetti	106	F		F			
Applique da parete	77	Faretti al led	77	Fascette stringitubo	68		
Argani elettrici e manuali + accessori	40-41	Fermapiatti e fermalibri	47	Fermaporta e chiusura per porte	30-31		
Asta telescopica p/antenna	20	Filtri docce e pompe di sentina	68	Fissabagagli	119-121		
Aste igloo e aste di colmo per tende	110-111	G		G			
Attacchi molle a gas	56	Ganci	116/128-131	Ghiacciaie portatili	136		
Attacchi scale per cuccetta	12-13	Ghirba	60/106	Gilet obbligatorio per sosta	39		
Autoclavi	62-63	Gonfiatori	108-109	Gradini in plastica	34-35		
Avvolgitubo	97	Gradini pieghevoli	34	Gradini scale per cuccetta	14		
B		B		Griglie aerazione	33		
Bandiere	118	Gradini scale per cuccetta	14	Guarnizioni gas	36		
Barre di carico-portapacchi	18/20	I		I			
Barre fermabici	29	Imbuto per carburante	136	Impermeabilizzante	116		
Base per tavoli e tubo	53	Impugnatura per cavi elettrici	98	Impugnatura per cavi elettrici	98		
Basi per paletti	110	Indicatore livello gas	38	Innesti rapidi	60		
Battery tester	86	Interruttori - deviatori	88-89	Inverter	90-91		
Beccucci snodati per rubinetti	66	K		K			
Bici pieghevoli	137	Kit lavaggio barca	98	Kit pulizia	99		
Binocoli	107	L		L			
Bitte	133	Lamiera di rinforzo tetto	20	Lampada da carteggio	76		
Bobinette treccia	125	Lampade alogene	77	Lampadine alogene e a led	78-79		
Bocchettoni serbatoio	71	Lavatrice	97	Lavelli e pilette	67		
Boiler ati	68	Liquido W.C.	101	Livella a piramide	39		
Bomboletta fughe gas	38	Lubrificante	104	Lucchetti	118		
Borchie	116-131	Luci da interno a led	74-75	M			
Bottoni	115	M		Macchina caffè' 12V.	73		
Braccetti portabici	27	Maniglie	31	Maniglie tientibene	47		
Bussole	107	Martello	113	S			
C		C		S			
Canestri carburante	135	Canestri carburante	135	Sacca portabici	137		
Carica batterie	90	Carica batterie	90				
Carrello pieghevole	138	Carica batterie	90				
Carta igienica	101	Caricatore per cavi elettrici	108-109				
Cassetta porta attrezzi	103	Caricatore per cavi elettrici	108-109				
Cassetta pronto soccorso	39	Caricatore per cavi elettrici	108-109				
Cassette portabatteria e accessori	87	Caricatore per cavi elettrici	108-109				
Cavi batteria	89	Caricatore per cavi elettrici	108-109				
Centralina regolatore gas	36	Caricatore per cavi elettrici	108-109				
Cesoie	128	Caricatore per cavi elettrici	108-109				
Cestino	136	Caricatore per cavi elettrici	108-109				
Ciabatta Schuko	80	Caricatore per cavi elettrici	108-109				
Cinghia fermaserbatoio	87	Caricatore per cavi elettrici	108-109				
Cinghie fissabagagli	119	Caricatore per cavi elettrici	108-109				
Cinghietti portabici	26	Caricatore per cavi elettrici	108-109				
Connettore neowater	70	Caricatore per cavi elettrici	108-109				
Contenitore acqua pieghevole con rubinetto	58	Caricatore per cavi elettrici	108-109				
Contenitore portascarpe per bagno	51	Caricatore per cavi elettrici	108-109				
Contenitori pieghevoli	51	Caricatore per cavi elettrici	108-109				
Copribici	28	Caricatore per cavi elettrici	108-109				
Corda elastica lettini	106	Caricatore per cavi elettrici	108-109				
Corde elastiche	120-123	Caricatore per cavi elettrici	108-109				
Cornici interruttori prese CBE	84	Caricatore per cavi elettrici	108-109				

Sacche e contenitori impermeabili	139
Saldatore 12V.	73
Salvacadute	13
Scale cuccetta	12-13
Scale esterne	15/16/18
Scrocchi	31
Secchi	102
Serbatoi acqua e accessori	69
Serbatoi benzina	135
Serbatoio di espansione	68
Serrature e chiavi	30-31
Sigillante Sikaflex	104
Slitta per tavoli	52
Sotto bicchieri	138
Spazzole a mano	103
Spazzolino W.C.	100
Spazzoloni pulizia T-Brite e accessori	99
Spilloni	113
Spine, prese e interruttori CBE	83-85
Spinotto universale	93
Staccabatterie	89
Supporti a parete TV LCD	94
Supporti docce	60
Supporti pannelli solari	86
Supporti tavoli	52-53

T

Taniche carburante	135
Taniche carrellate per acqua	70
Taniche per acqua con rubinetto	106
Tappi	69/110/116
Tappo a 2/3 razze	71
Tasche portaoggetti	49
Tela adesiva	105/116
Telo impermeabile copribici	28
Teloni rafia	117
Tendine oscuranti	33
Tenditori elastici	116
Tenditori regolabili tende	114
Torce	95
Tornichetti	115
Trecce e corde	124-127
Triangolo di sosta	39
Trousse bagno	51
Tubi acqua	97
Tubi acqua retinati / spiralati	58
Tubi doccia	59
Tubi lavaggio barca	98
Tubo autosvuotante	136
Tubo GPL	38
Tubo per tavoli	53
Tubo piatto per acqua	59

V

Valvole	71
Ventilatore 12V.	94

W

WC chimico portatile	101
----------------------	-----

A

Accessories for trolleys	42-44
Adhesive sealant	104
Adhesive tapes	105/116
Antenna holder pole	20
Anti-slip mats for glasses	138
Autoclaves	62-63

B

Bars kit	18/20
Ball valves	61/71
Bars for garage	29
Battery boxes and accessories	87
Battery cables	89
Battery chargers	90
Battery switches	88
Battery Tester	86
Bike cover	28
Binocular	107
Boilers	68
Buckets	102
Bunk bed ladders	12-13
Buttons	115
Plates and books stopper	47

C

Camping stand	140-141
Cap 2 spokes	71
Cap 3 spokes	71
Caravan cycle-holder	22-25
Ceiling lights	76
Chemical toilet	101
Circuit breakers	89
Clamps	68
Clamps for battery	86
Cleaning brushes	99
Cleaning clothes	100
Cleaning kit	98
Cleats	133
Coffee maker	73
Compasses	107
Connection adapter for taps	60
Connections for water tanks	70
Control unit with gas controller	36
Covers in raffia	117
Cradles for cycles	26
Cycle-holder arms	27
Cycle-holder belts	26
Cycle-holder spare parts	26-27
Cycle holders	22-25
Cylinder for gas leak detection	38

D

Door lock	30-31
Door locks	30-31
Double action stirrup pump	107

E

Elastic cord for bunks	106
Electric inflator	107-109
Electrical and manual winches + accessories	40-41
External ladders	15/16/18
Extractor key	31

F

Filters for showers and pumps	68
First aid kit	39
Fixing bars for cycles	29



Flags	118
Flat hose	59/97
Folding bags	51
Folding bikes	137
Folding steps	34
Folding trolley	138
Foot inflator	107-108
Frames for CBE socket switches	84
Fuel tanks	135
Fuse holder	86

G

Garage ramps	29
Garbage holder	100-101
Gas accessories	36-38
Gas and GPL detector	94
Gas flex hose	36
Gas regulators	37
Gas springs	54-55
Gas springs mounting plates	56
Glass holders	106/138
GPL hose	38
Grommets	116/131

H

Hand brushes	103
Hair dryer	73
Halogen bulbs	78
Hand rails	47
Handles	31
Head torch	95
Heat cutting and sealing	128
High visibility jacket	39
Hooks	116/128-131
Hose reel	97
Hose shanks	72
Hoses for shower	59
Hoses for water	58

I

Inflators	108-109
Indoor led lights	74-75
Inlet for vent	71
Inverters	90-91

L

Latches	31
Led bulbs	79
Led light	77
Led spotlights	96
Level gauge for gas cylinder	38
Lifting ring	30
Lubricating	104
Luggage fasteners	119

M

Manual winches	41
Mixers	64-66
Multi basket trolley	136
Mushroom vent	32

N

Neoprene extension lead cable	80
Net for caravan beds	13

O

Object-holders	48-50
Object-holders pockets	49
One-component	104

P		Taps	64-66
Padlocks	118	Tent accessories	110
Panels for exceeding loads	29	Tent pegs	112-113
Pipe for tables	53	Tent poles	111
Plastic steps	34-35	Thimbles	132
Plate stopper	47	Toilet brush	100
Plugs, sockets and switches CBE	83-85	Tool box	103
Portable iceboxes	136	Torches	95
Powder fire extinguisher	39	TV holders	94
Pumps	61/107	V	
Pyramid level	39	Ventilators	33/94
Q		Vents	32
Quick-coupling	60	Vents for tanks	71
Quick fittings	72	Veranda tent poles	111
R		W	
Remote display for battery charger	90	Warning triangle	39
Rigid water tanks	69	Washing machine	97
Roof duct	86	Water hoses	97
Roof racks	16/18	Water savers	66
Rope cutters	128	Water tanks and accessories	69-70/106
Ropes	124-127	Waterproof bags and cases	139
Rubber straps for luggage	120-123	Water-proofer	116
S		Wedges for parking	45
Schuko multi-socket extension lead	80	Wheel tanks	70
Self-draining pipe	136		
Shoe rack	51		
Shower cases	58		
Shower hoses reduction	60		
Showers	57		
Sikaflex	104		
Single control mixer	64-66		
Sinks and waste kit	67		
Ski rack	28		
Snap-hooks	134		
Sockets and plugs	46/80-82/92-93		
Solar charge regulator	86		
Solar sunshower	60/106		
Soldering iron 12V	73		
Spare parts for bunk bed ladders	14		
Spare parts for external ladders	15/17/19		
Spare parts for roof racks	17-20		
Spiraled hoses	58		
Spotlight	77		
Standing holders	35		
Steps for bunk bed ladders	13		
Stern wheels	44		
Stern wheels for trolleys	44		
Stiffening plate for roof	20		
Stowage hammock	106		
Straps	119-123		
Stretchers for tents	114		
Studs	115		
Sunset curtains	33		
Supporting kit for solar panels	86		
Supports for igloo tents	110		
T			
Table base	53		
Table slide	52		
Table supports	52-53		
Tank for fresh water	68		